

# CHICONE CUSTOM MILLWORK

Architectural and Commercial Molding

## PROFILE CATALOG





## **Commercial and Residential Molding Available:**

### **Molding Specifications**

At Chicone Cabinetmakers we are dedicated to maintaining an American tradition in fine woodworking. Moldings can add a splash of charm to a room, transform an existing façade, restore original beauty, or fulfill unrealized potential. A small improvement can go a long way in adding character to your home. We can work within a full genre of architectural styles, recreating original moldings or updating a staid interior with a unique contemporary design. Our work down to the smallest detail, reflects our respect for the living and natural beauty of wood. Our moldings combine precision and quality together with the natural warmth of the finest hardwoods, to give you a product that will meet your needs and exceed your expectations.

We at Chicone Cabinetmakers are committed to maintaining the highest level of quality in all our products. Natural hardwoods are a living medium and certain inconsistencies and variations are inherent in the wood itself. We believe that these natural variations contribute to the character and beauty of natural hardwood moldings. These may include, but are not limited to, color variations from sapwood and heartwoods, knots, and worm holes. Cosmetic variations, however, will not affect the structural integrity of the moldings.

Our machining process may reveal additional characteristics of the wood such as minor bows, twists, and crooks. These natural variations will not affect product quality or workability. Molding will exhibit some machining marks but we strive to eliminate all chatter marks. When the moldings are 3-1/2" or wider, there may be at least one glue joint running the length of the piece.

We offer our moldings by the lineal foot and will mill according to your length specifications as availability of material allows. Contact us today and let us help you with your next molding project.

# Art Deco

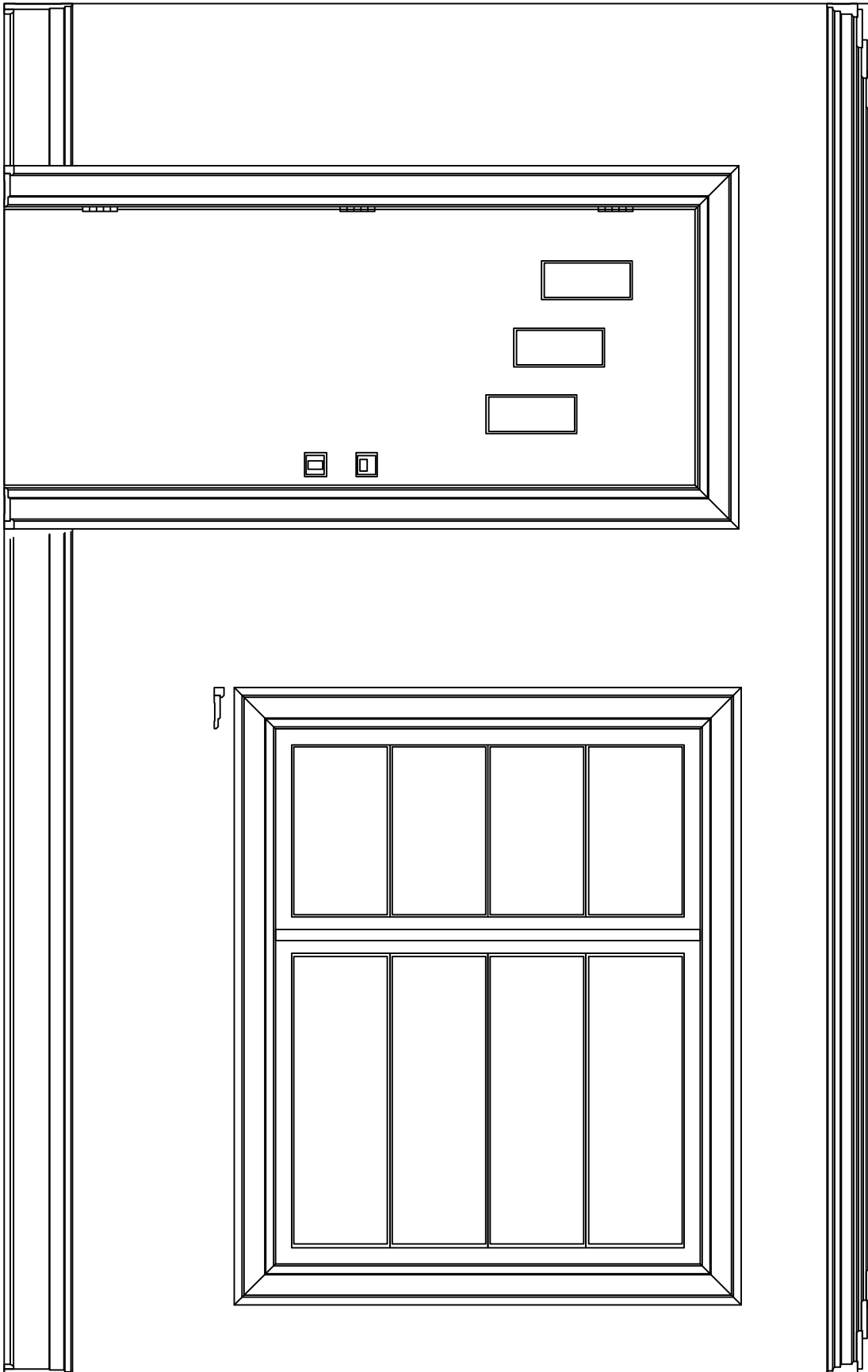

# Art Deco

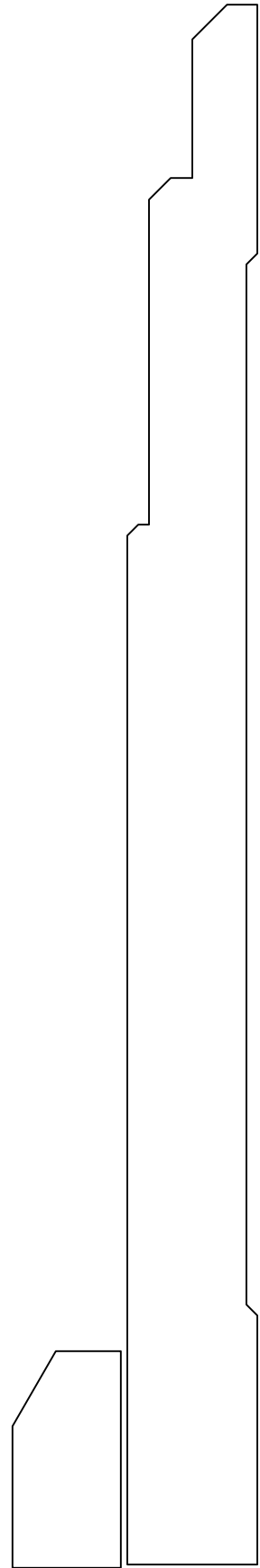
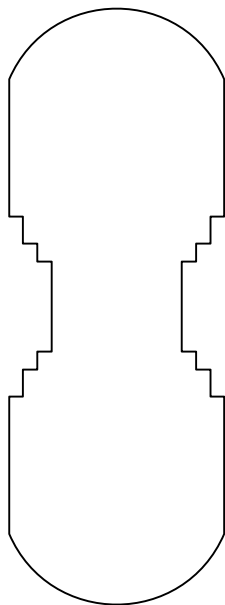
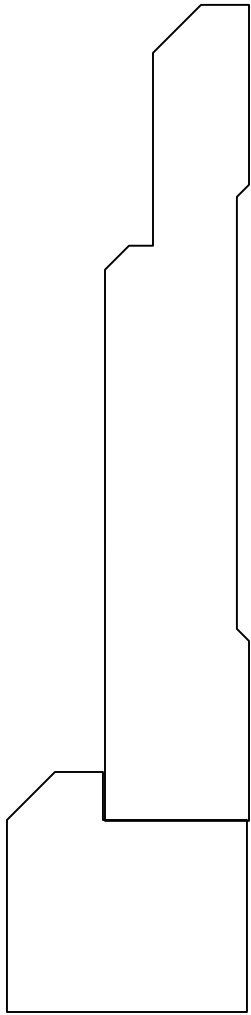

# Art Deco

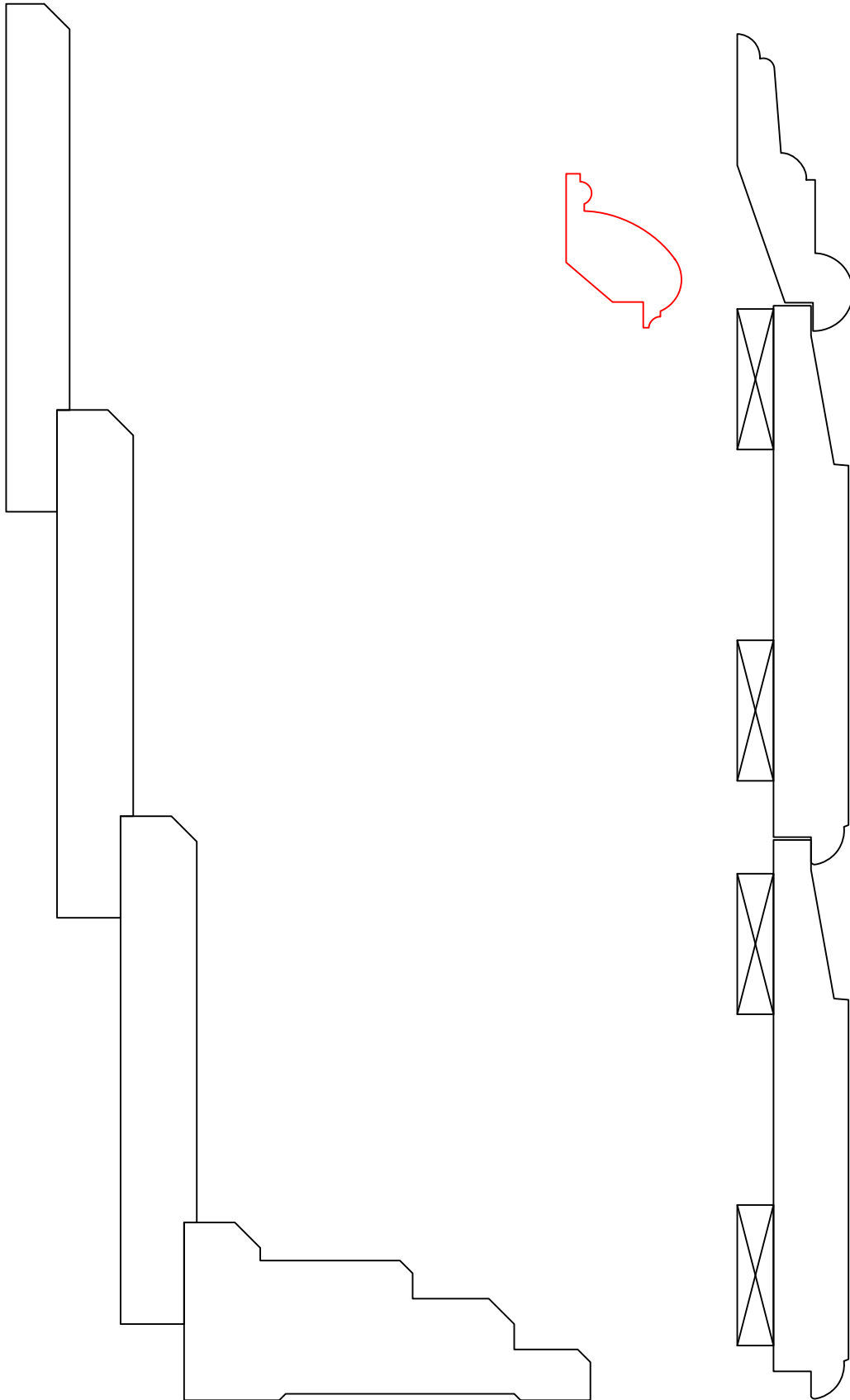

# Art Deco

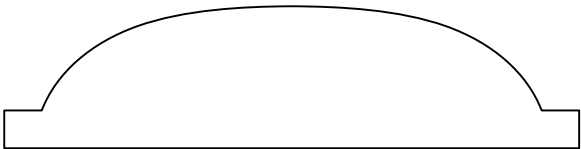
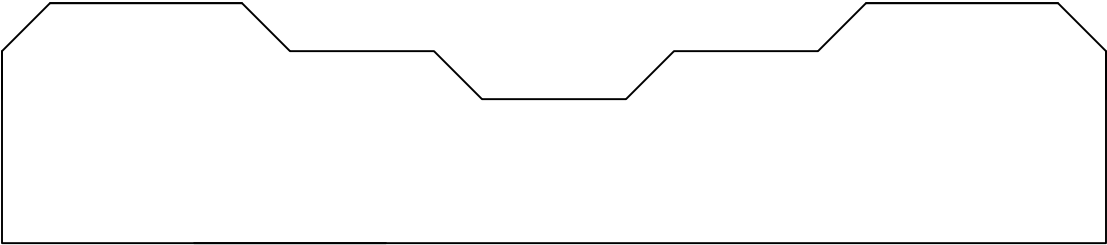
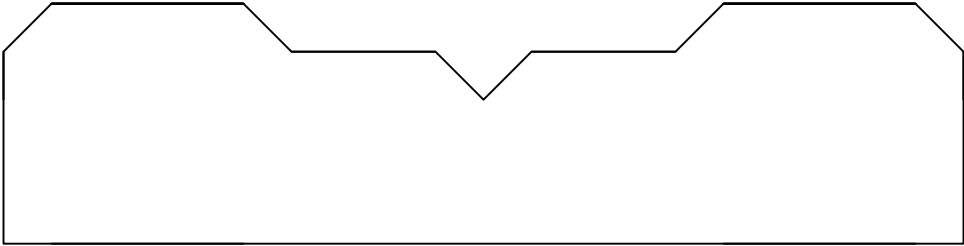

# Art Deco



SD 78 - .75 x 5.5

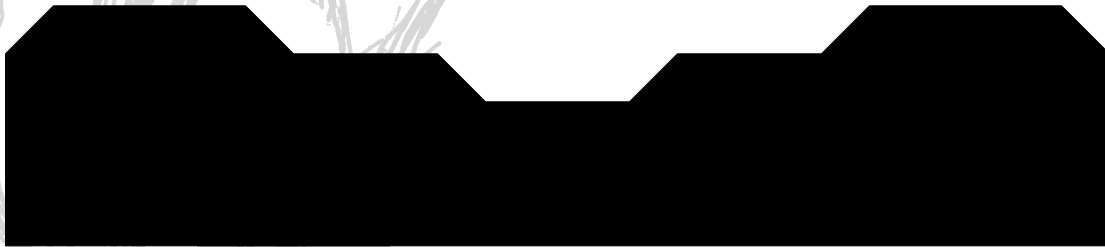

CHR 305 - 1.25 x 5.75

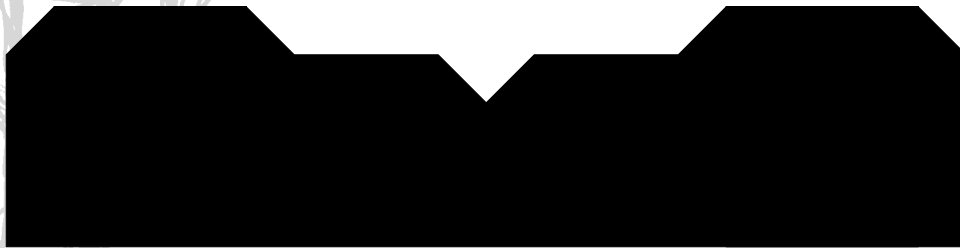

CHR 306 - 1.25 x 5

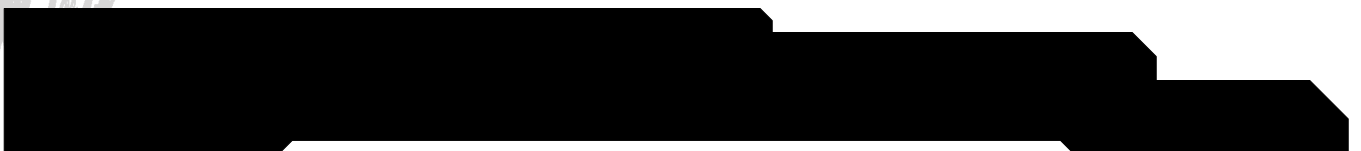

B 657 - .75 x 7 \*\*\*



SM 21 - .625 x 1.25

# Art Deco

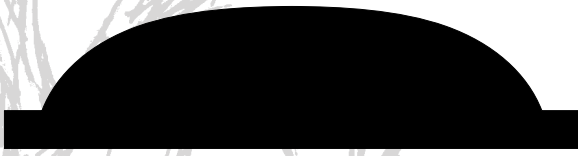

CHR 69 .75 x 3



HR 1551 - 1.125 x 3.125



CHR 9506 - 1.75 x 4



# Art Deco



CR 3319 - .625 x 5



CR 3318 - .75 x 5



BB 148 - 1.25 x 1.25



C 271 - .75 x 4.25

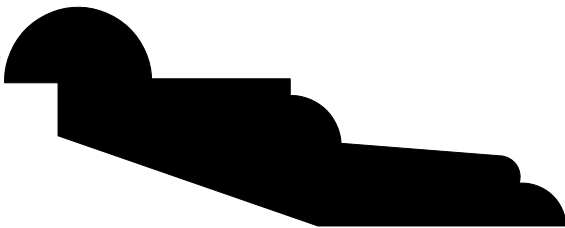

BC 141 - .75 x 3.063

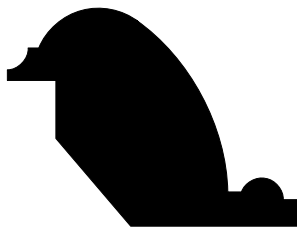

BC 135 - .75 x 1.75

# Bungalo

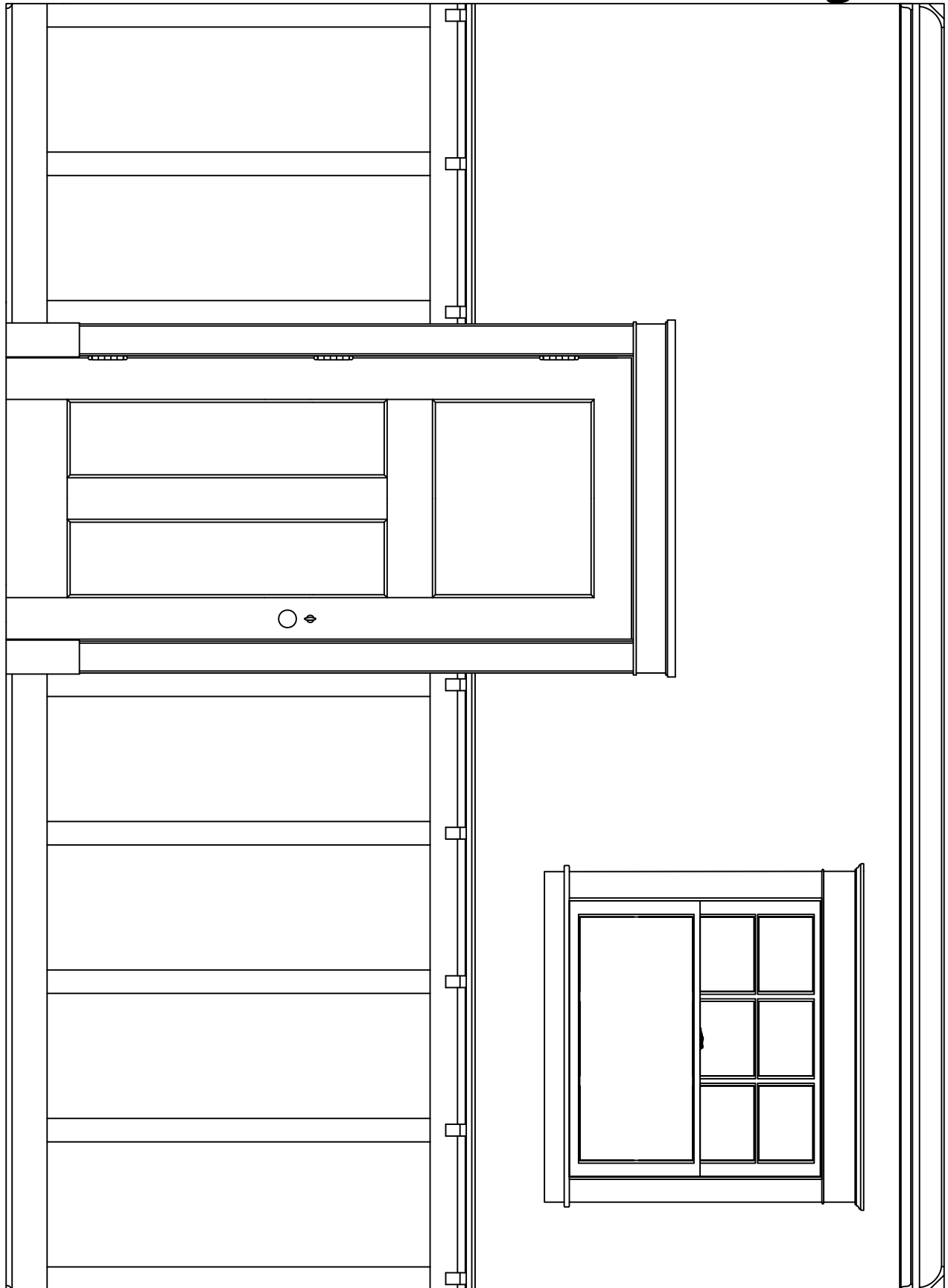

# Bungalo

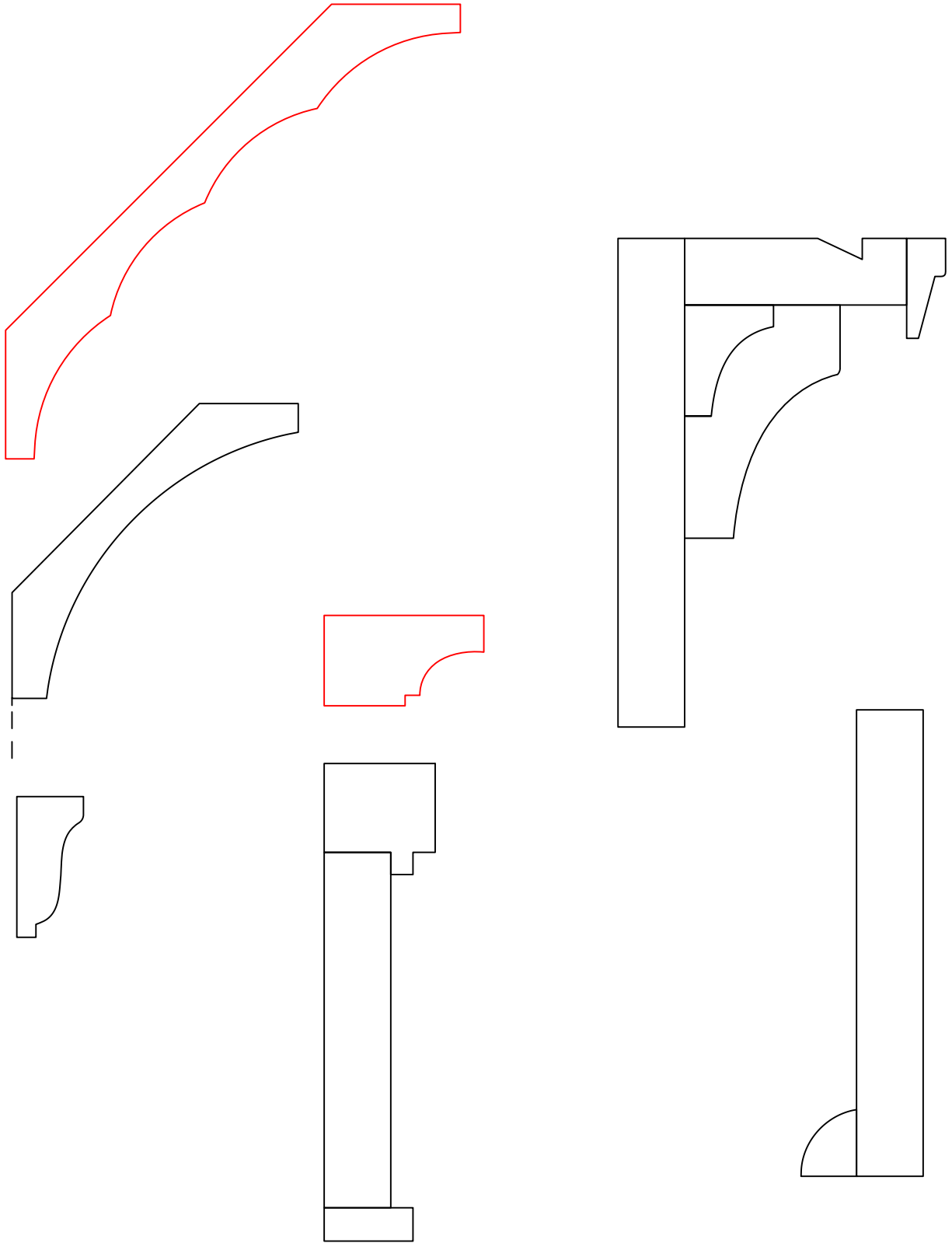

# Bungalo

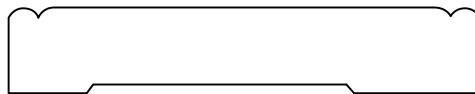
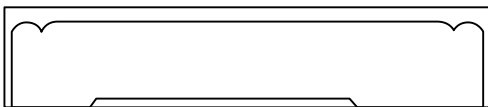
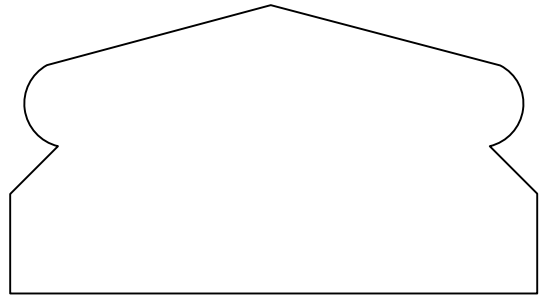
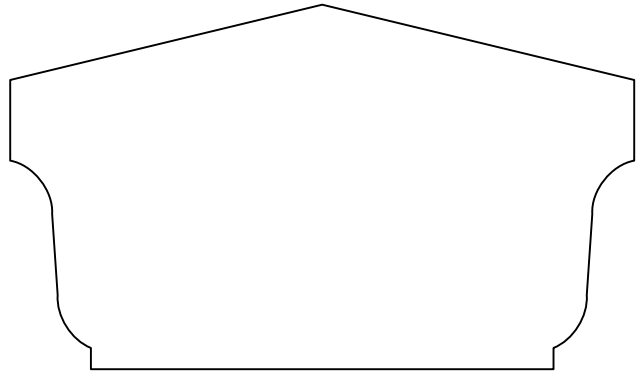
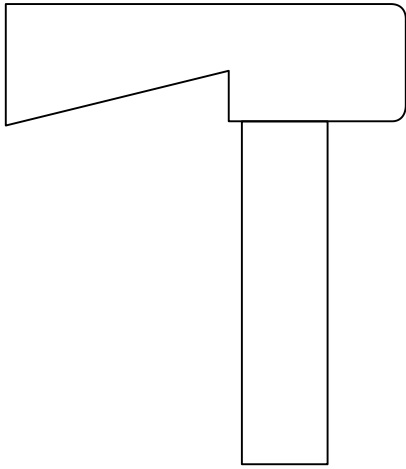

# Bungalo



CR 1128 - 1.25 x 7.25

CV 164 a - 1 x 5

# Bungalo



CR 18 - 1.125 x 2

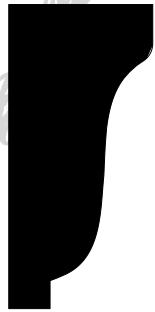

BC 153 - .75 x 1.563



CV 79 - 1.75 x 2.625

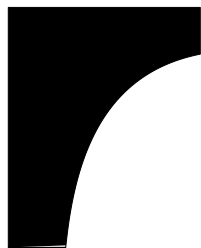

CV 78 - 1.25 x 1

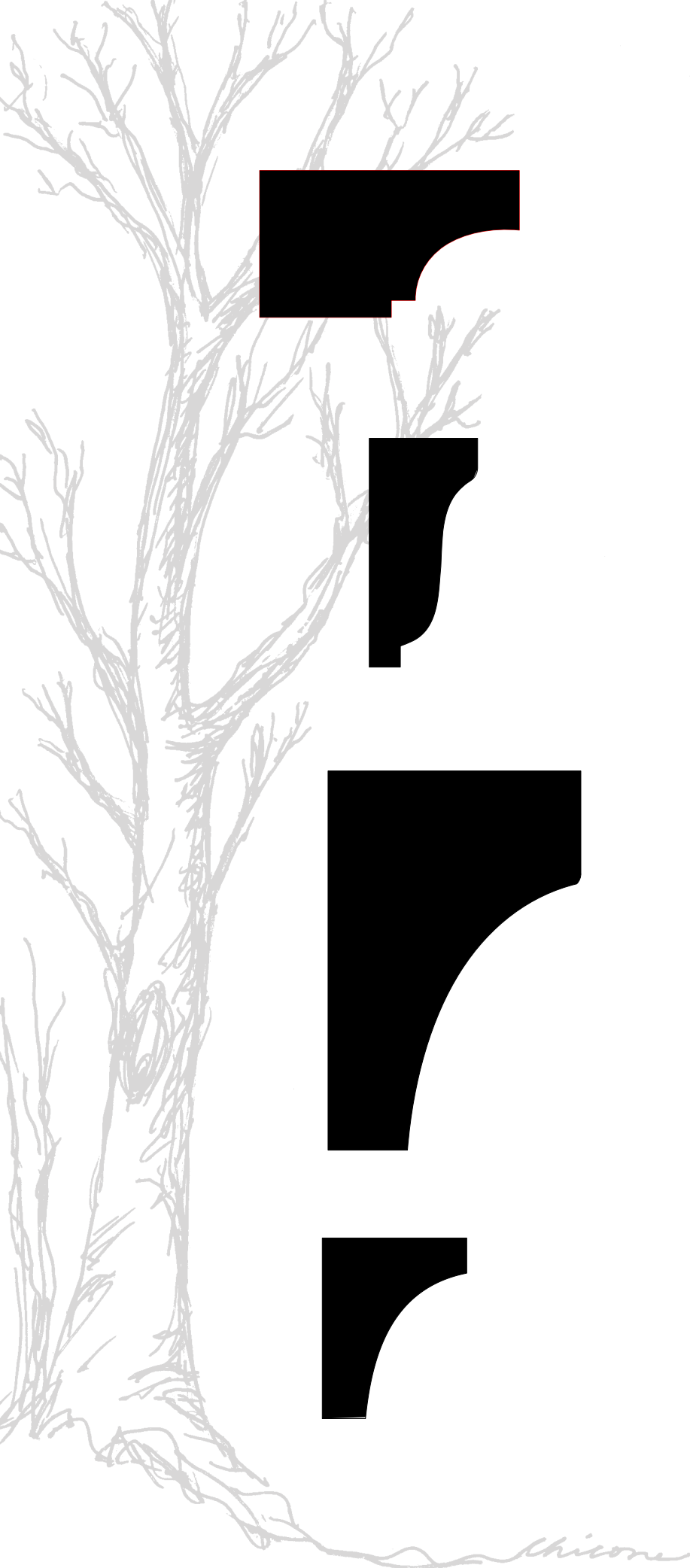

# Bungalo



PR 5 - .75 x 2.5

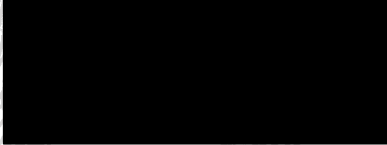

S4S - .75 x 2



S4S - .75 x 3

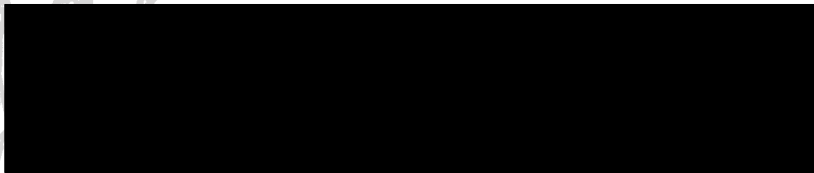

S4S - .75 x 4.25

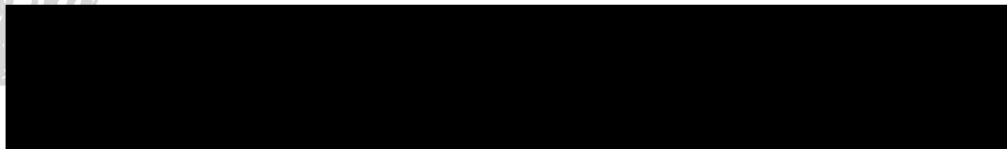

S4S - .75 x 5.25

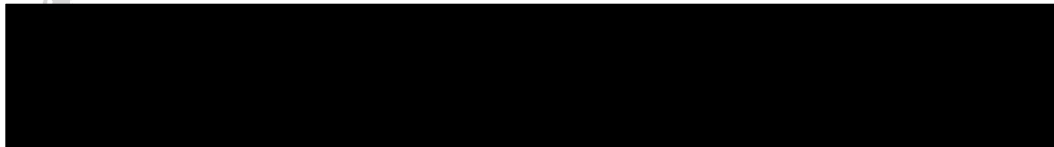

S4S - .75 x 5.5

# Bungalo



S 20 - 1.125 x 3.5



SM 24 - .438 x 1.125



N 16 - 1.25 x 1.25



S4S - .375 x 1

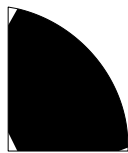

SM 23 - .75 x .625

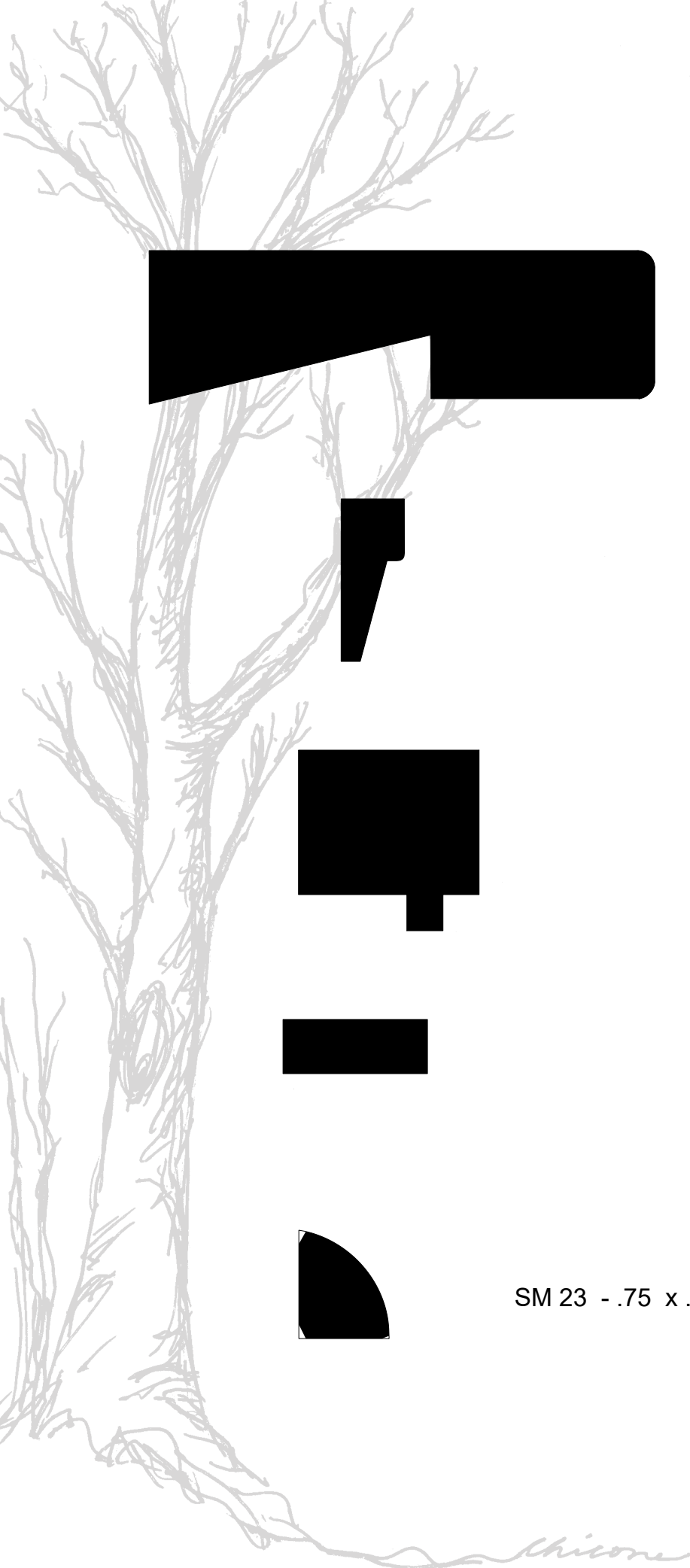

*Chicone*



# Bungalo



C 160 - .75 x 4.125



C 434 - .75 x 4.125

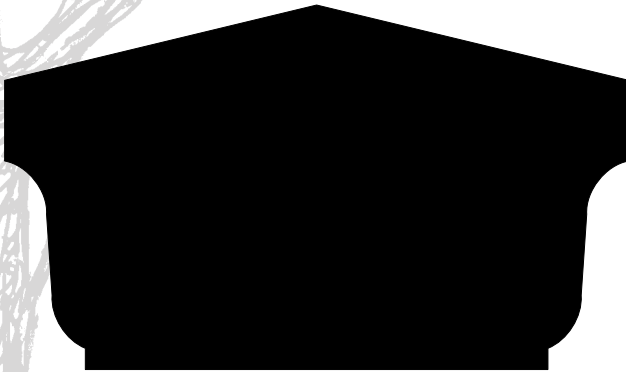

HR 90 - 1.875 x 3.25  
Bungalo

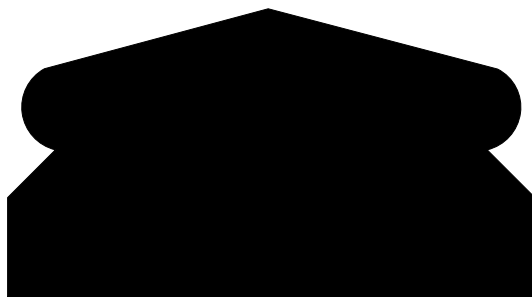

HR 91 - 1.5 x 2.75  
Bungalo

# Chesapeake Colonial

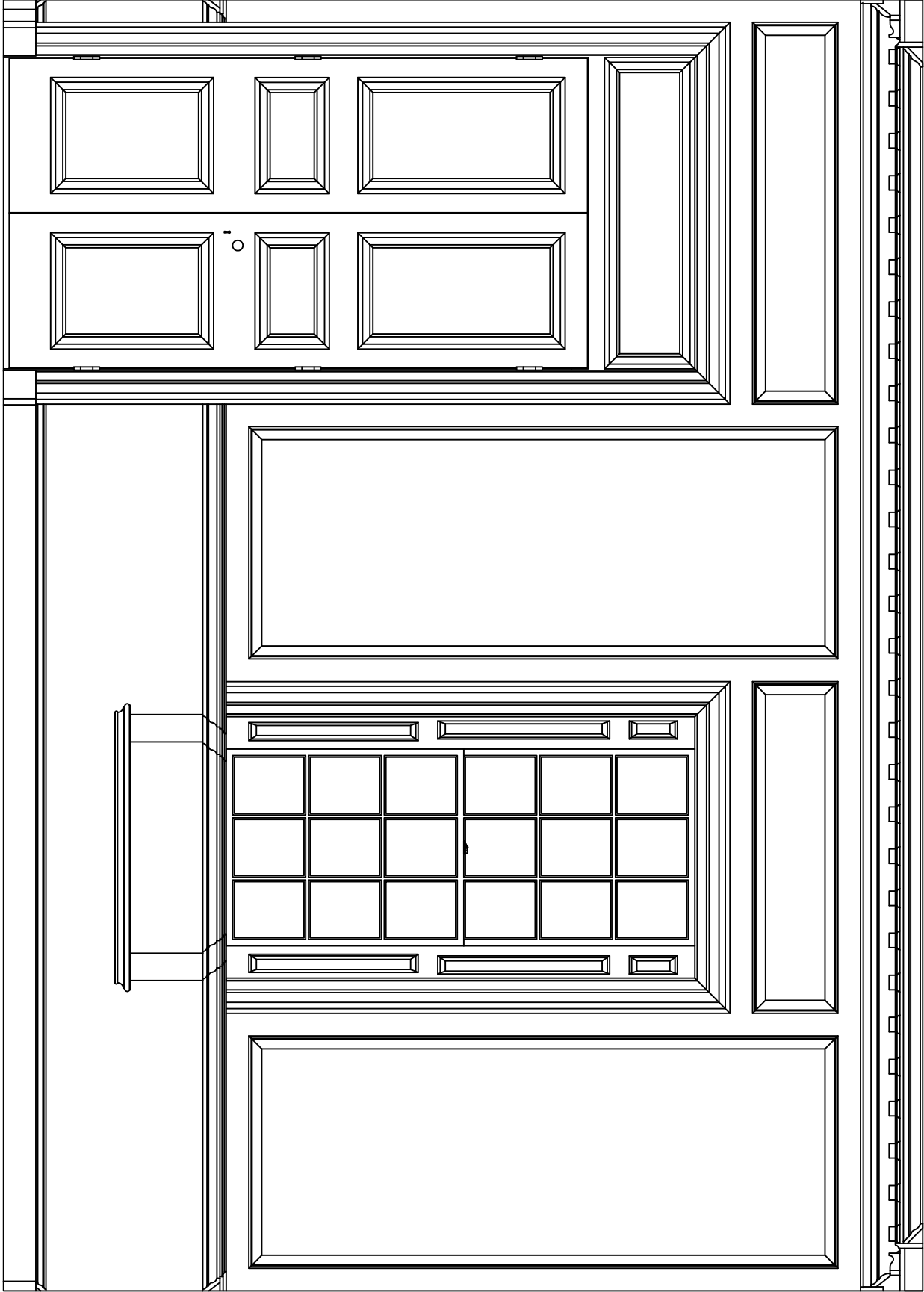

# Chesapeake Colonial

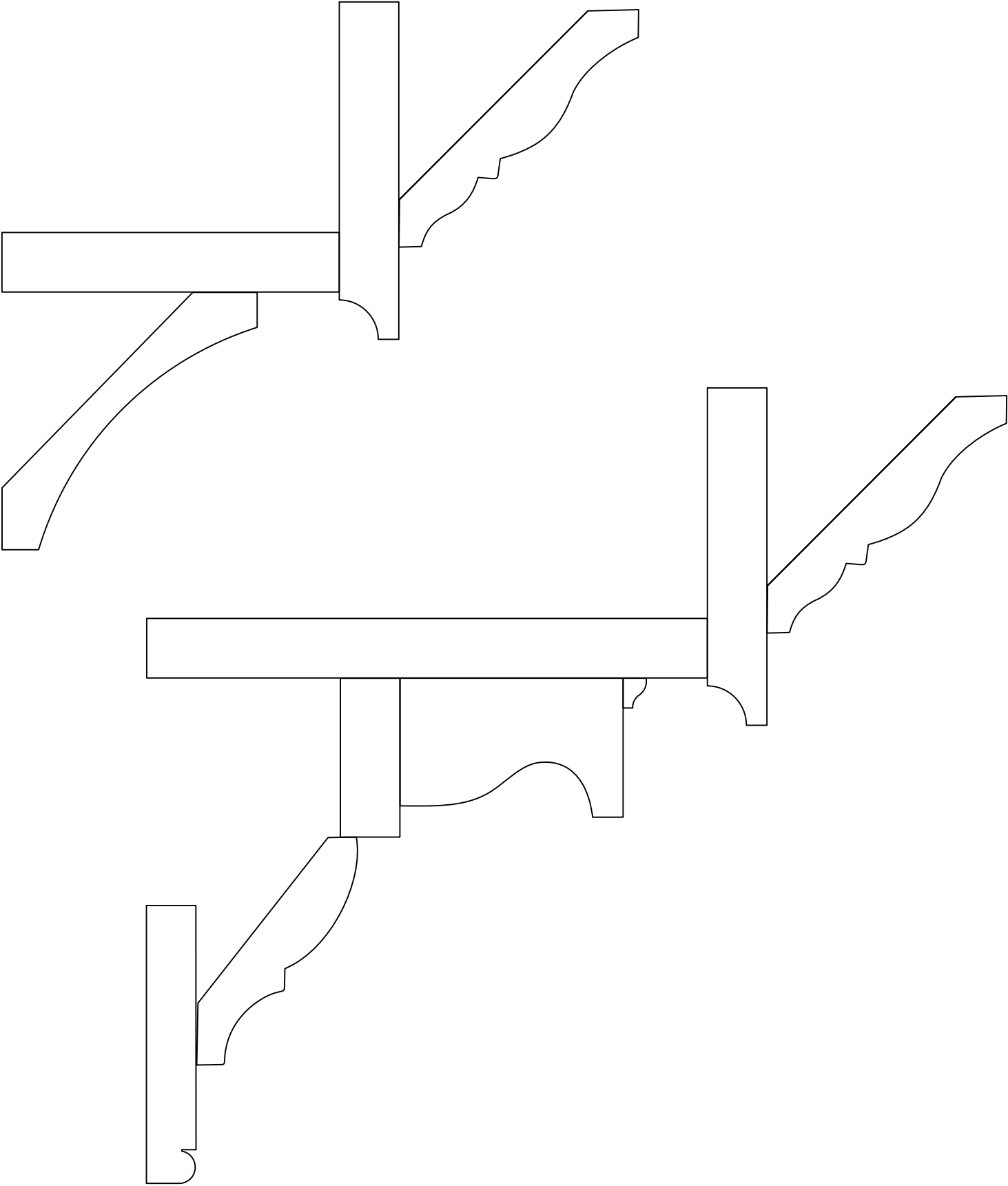

# Chesapeake Colonial

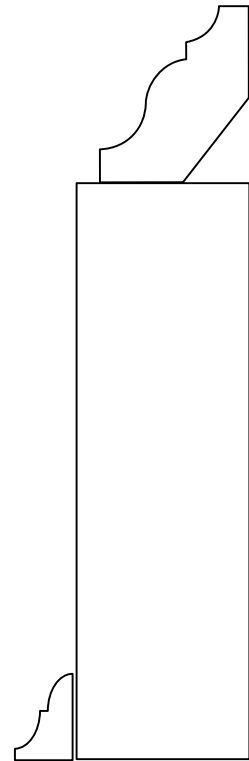
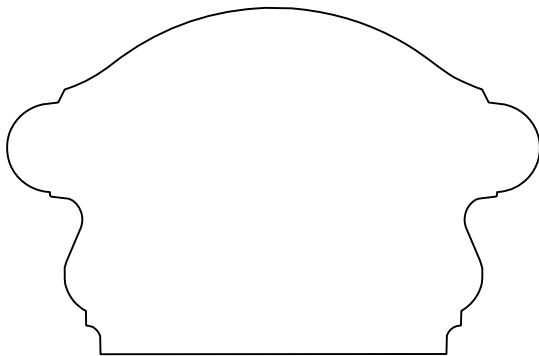
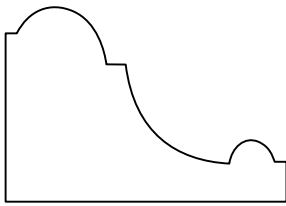
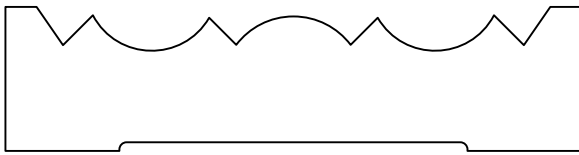
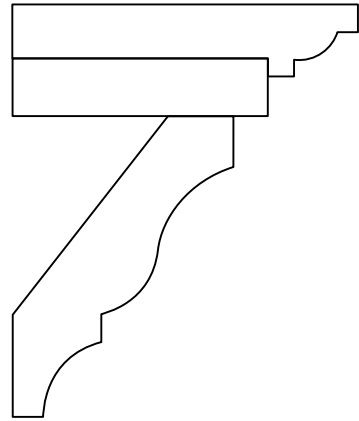
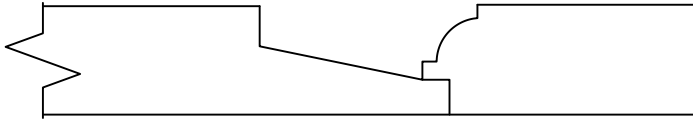
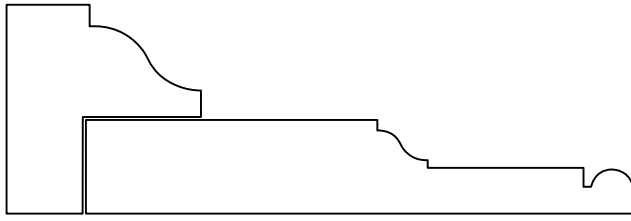

# Chesapeake Colonial

C 8848- .813 x 4.75



BB 149 - 1.813 x 1.813

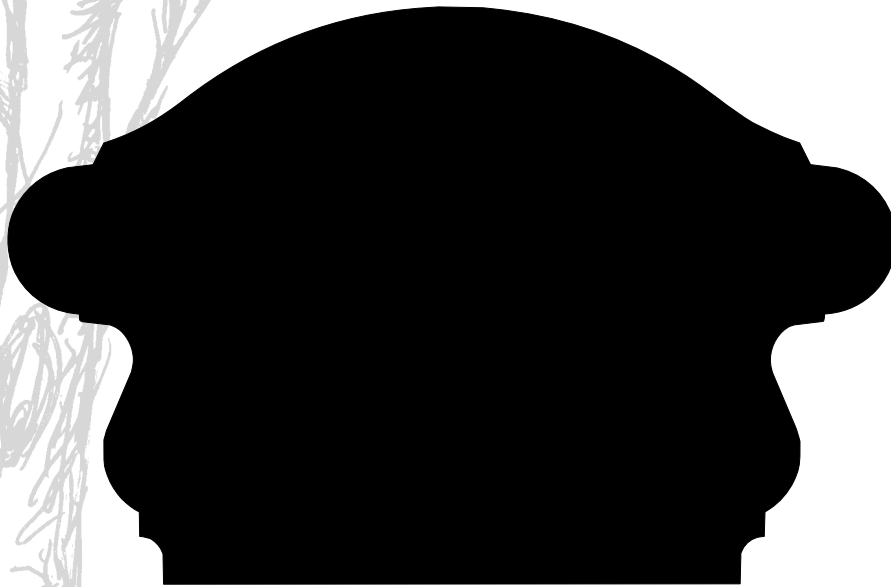

HR 4625 - 3 x 4.625



CR 352 - .625 x 3

# Chesapeake Colonial



CR 351 - .75 x 3.25



S4S - .5 x 2.25

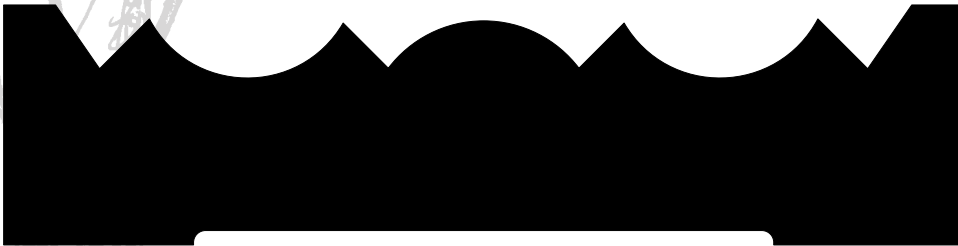

C214 - 1.25 x 5

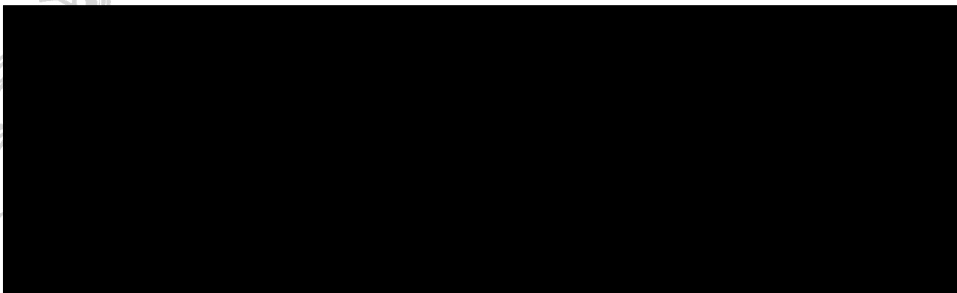

S4S - 1.5 x 5

# Chesapeake Colonial

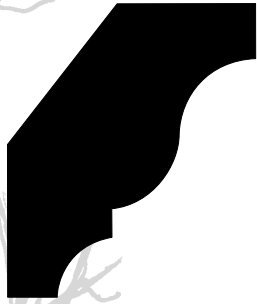

CR 20 - .75 x 2



SM 22 - .5 x .75

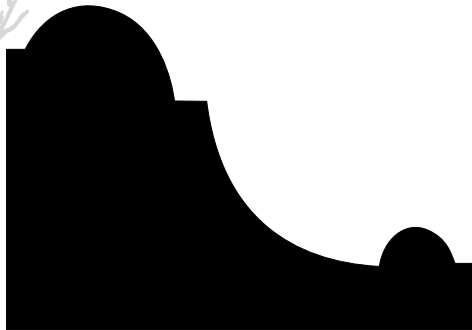

BC189 - 1.688 x 2.438

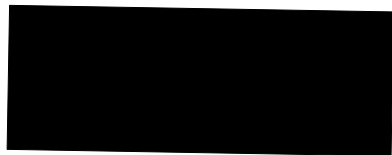

S4S - .75 x 2



C 252 - .625 x 3.5

# Chesapeake Colonial



CR 353 - .75 x 3.5



Ex 308 - 1.25 x 2.625



DM 38 - .313 x .375

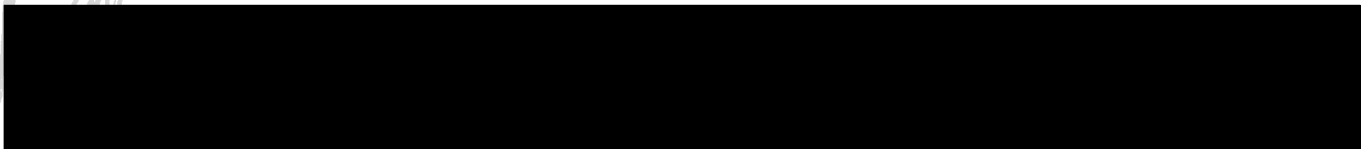

S4S - .75 x 7.063

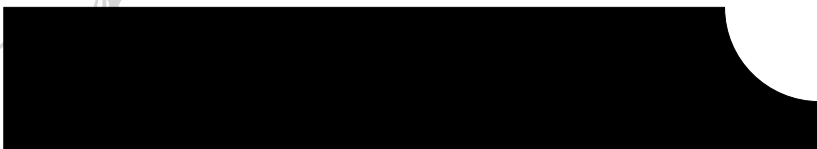

B 480 - .75 x 4.25 \*\*\*



# Chesapeake Colonial



CR 403 - .75 x 4.25



CV 164 .75 x 4.5



S4S - .75 x 4.25

# Colonial Revival

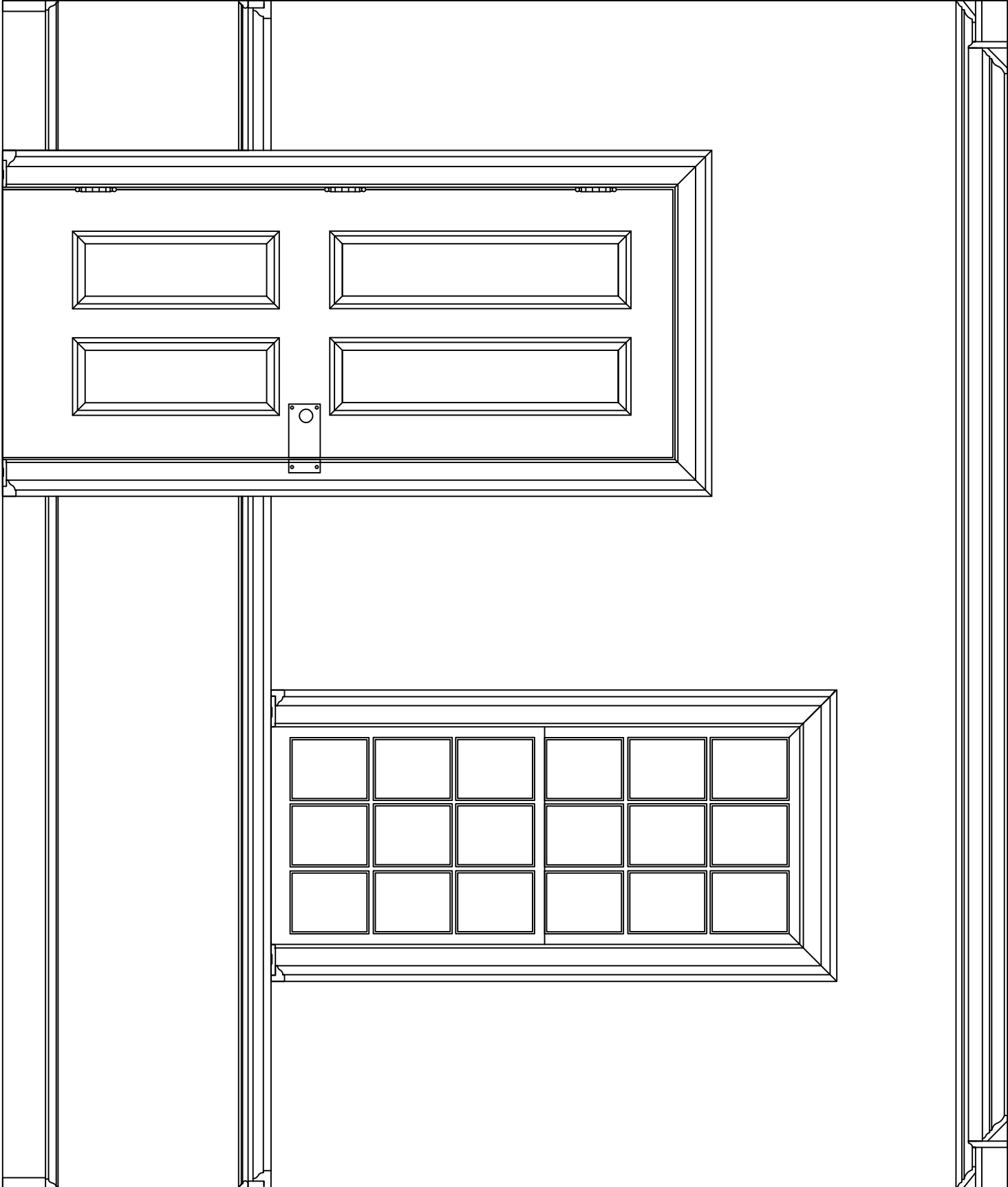

# Colonial Revival

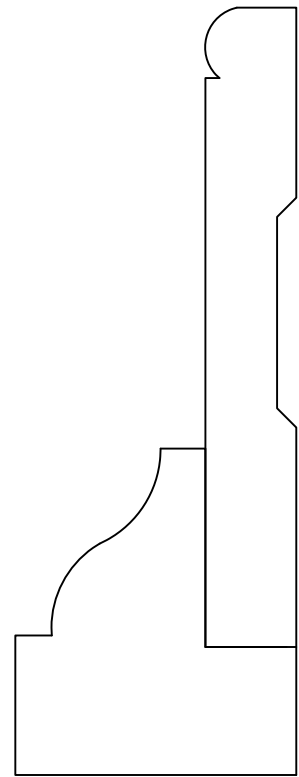
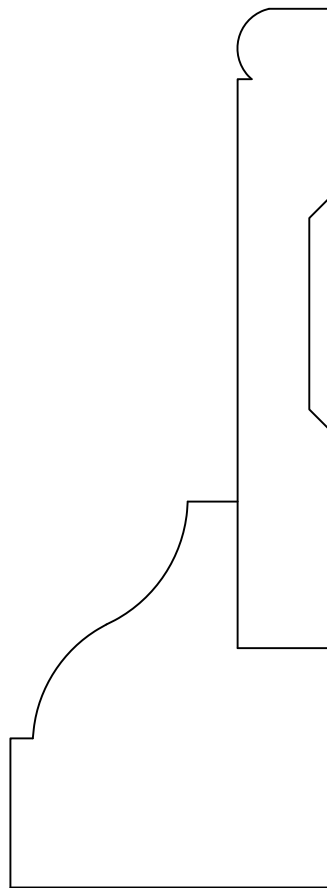
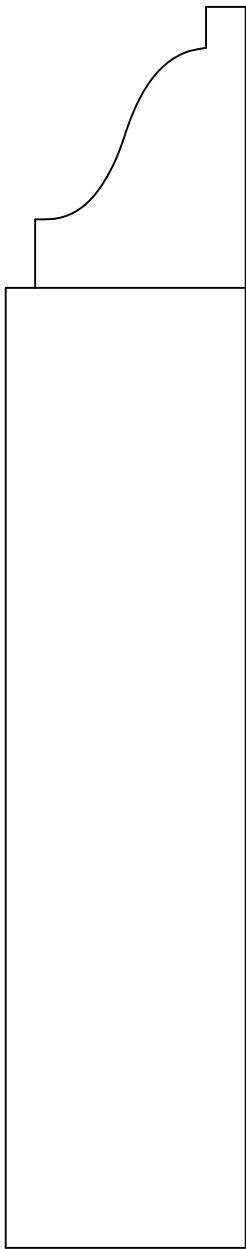
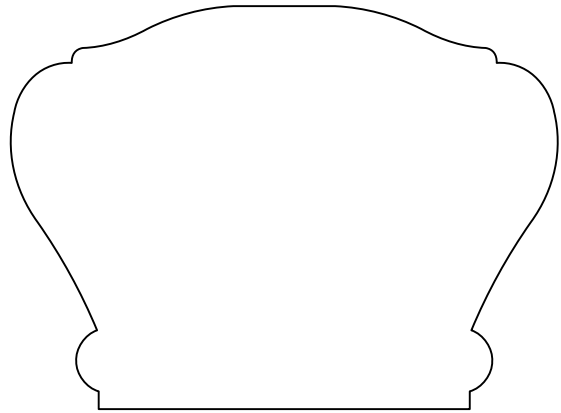

# Colonial Revival

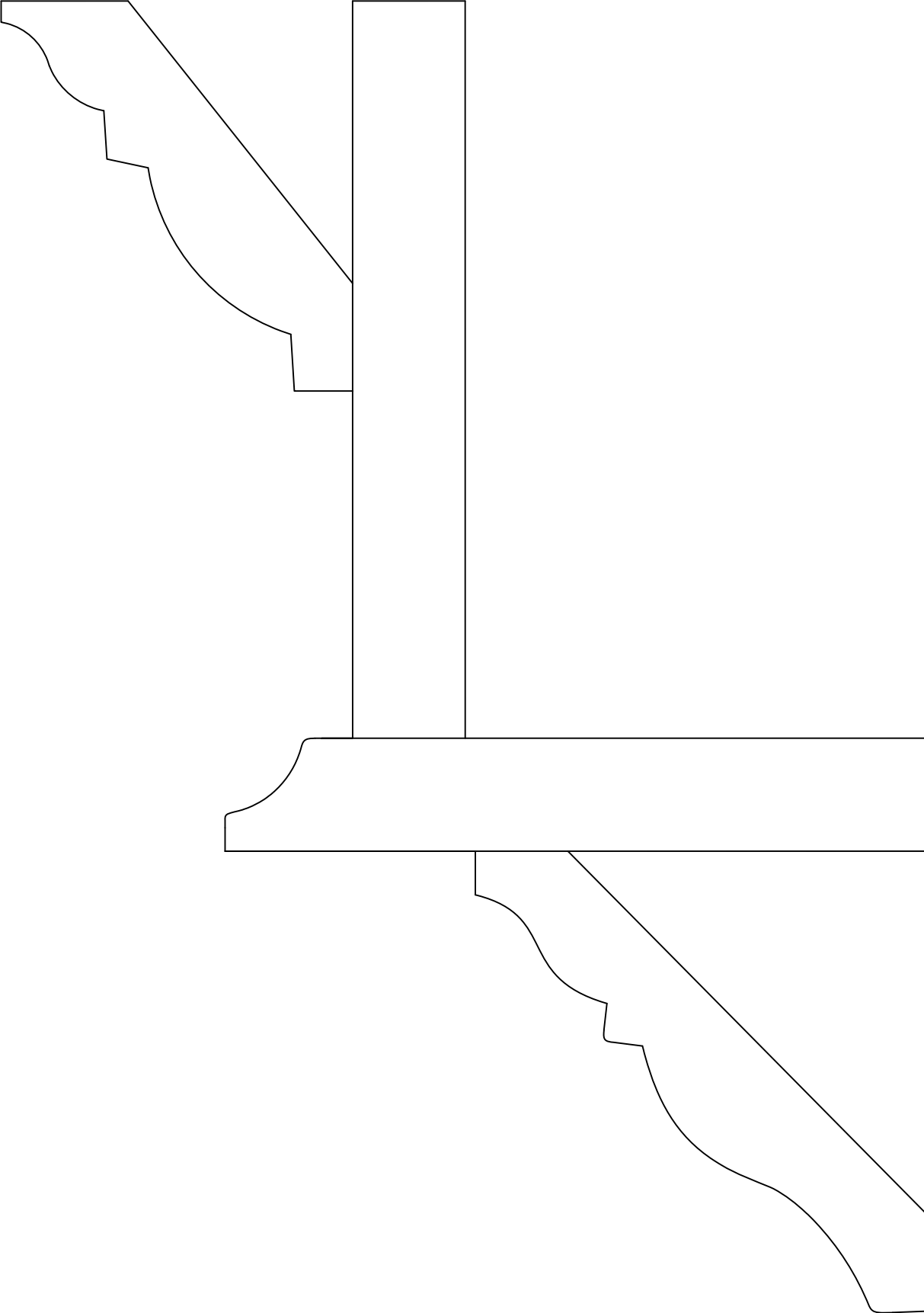

# Colonial Revival



BB 156 - 1.625 \*\*\* x 2



BB 149 b - 1.438 x 1.813

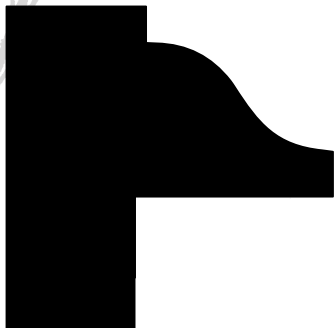

BB 149 a - 1.688 x 1.813



C 380 - .5 x 3.375

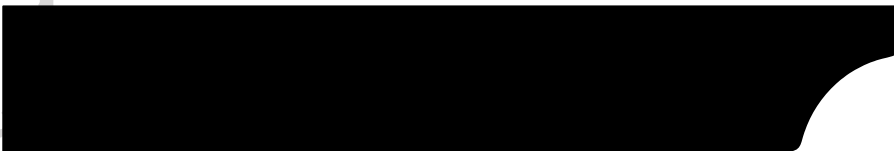

CR 1268 - .75 x 4.625

# Colonial Revival



BC 264 - 1.125 x 1.5



T 115 - .75 x .938



S4S - 1.25 x 5

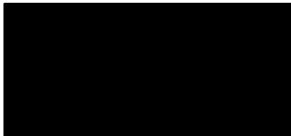

S4S - .688 x 1.5

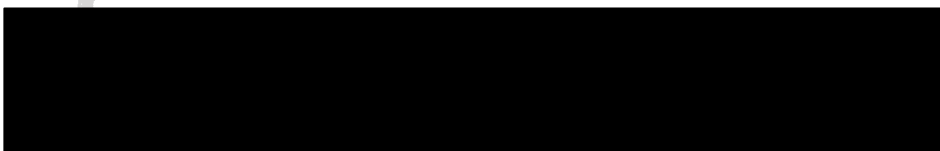

S4S - .75 x 5

# Colonial Revival



CR 403 - .75 x 4.25



CR 28 - .75 x 3.5

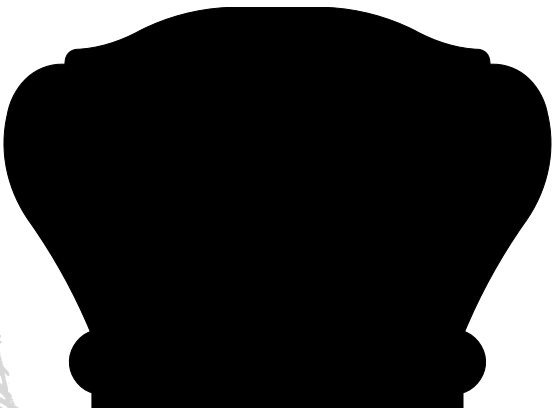

HR 97 - 2.125 x 2.875

# Craftsman

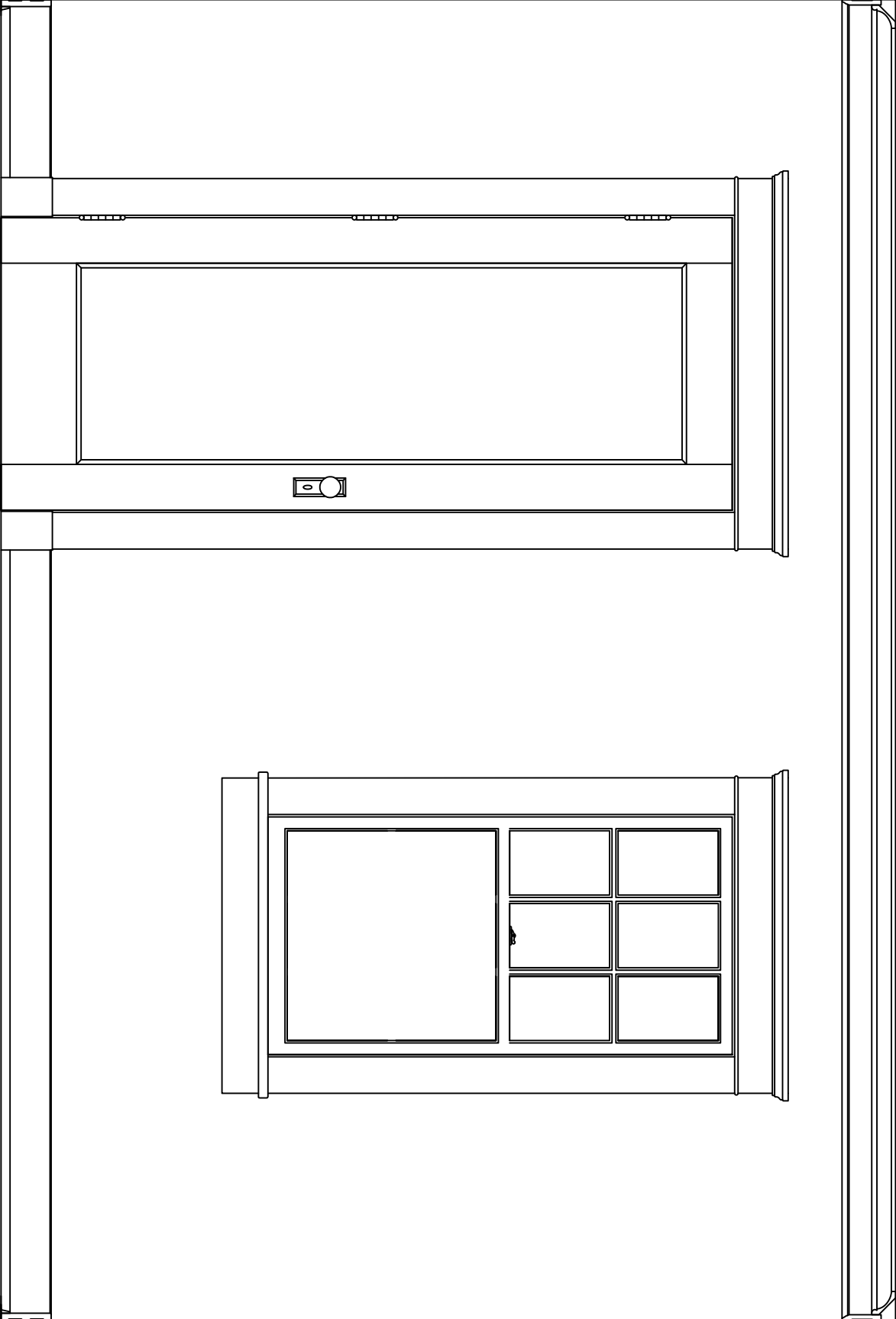



# Craftsman

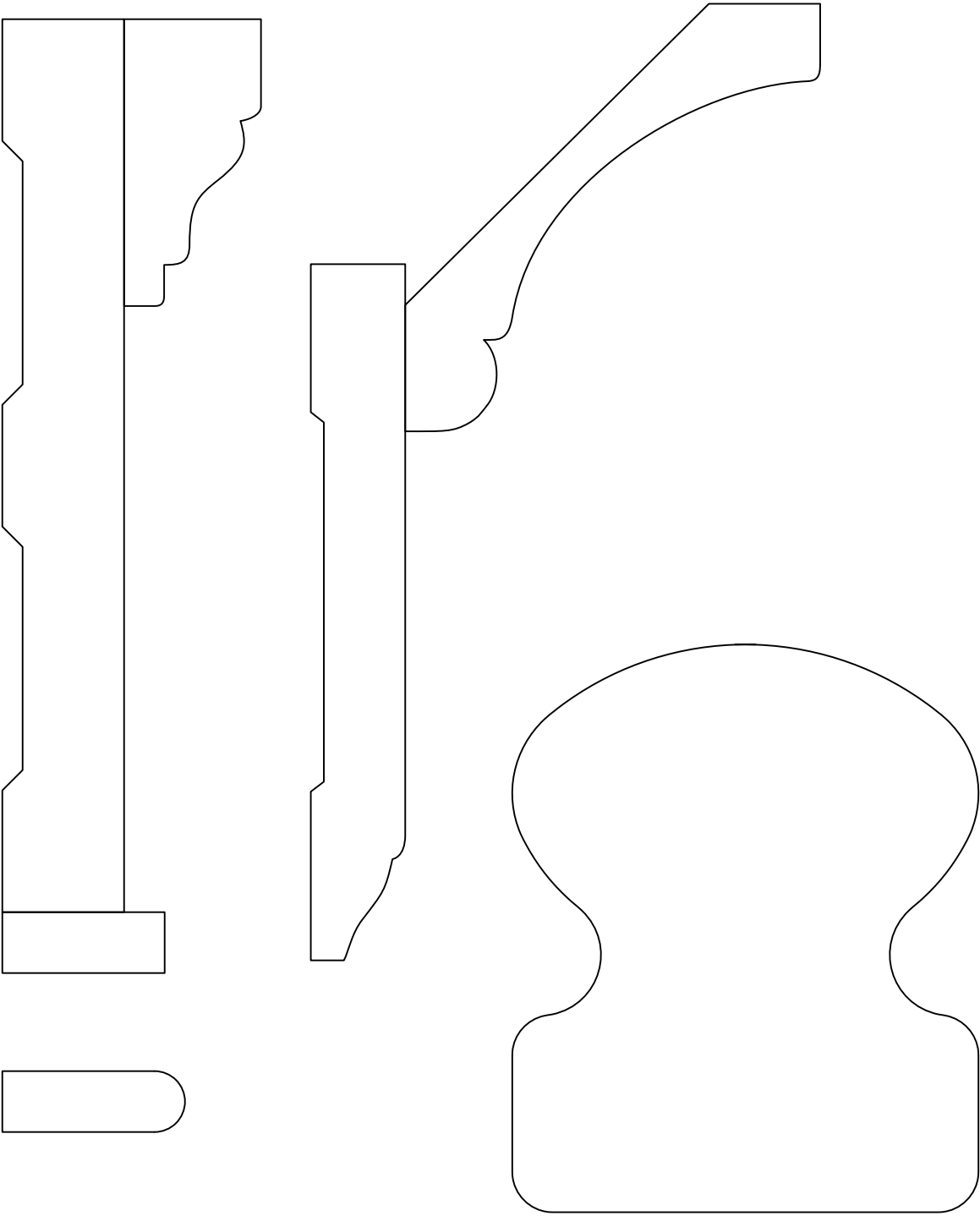

# Craftsman

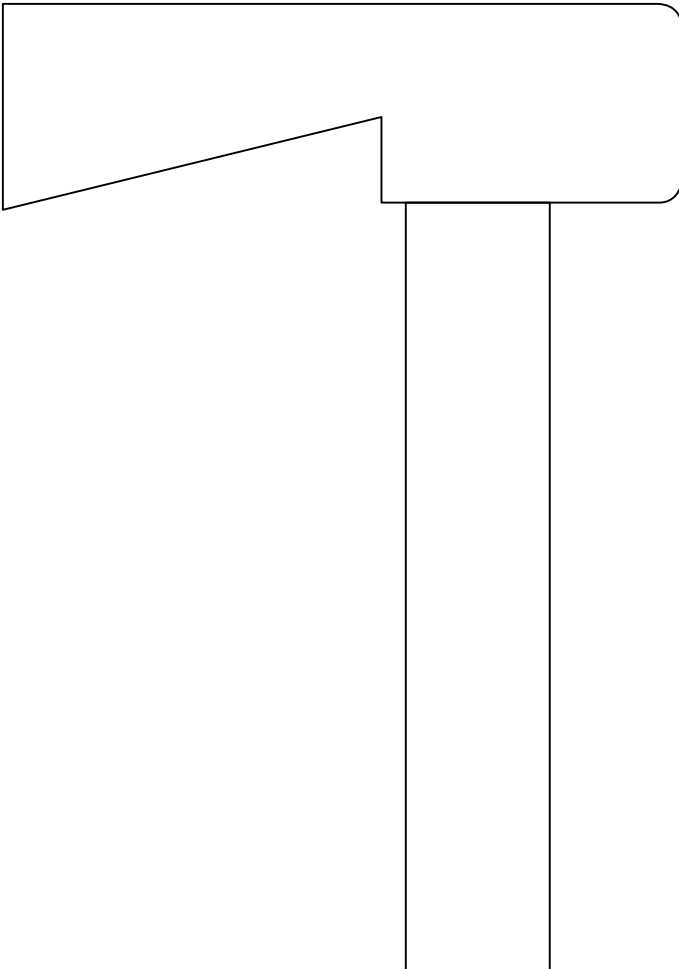
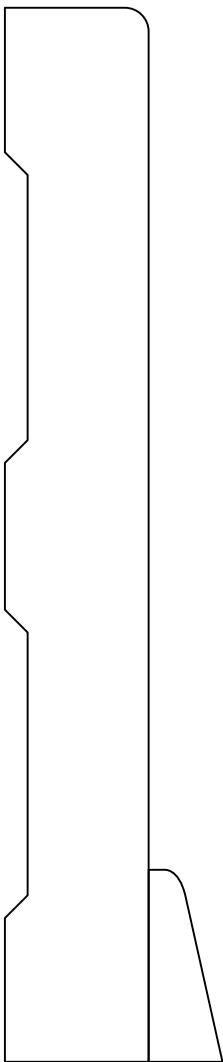
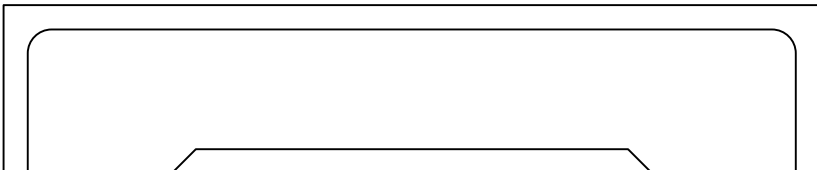
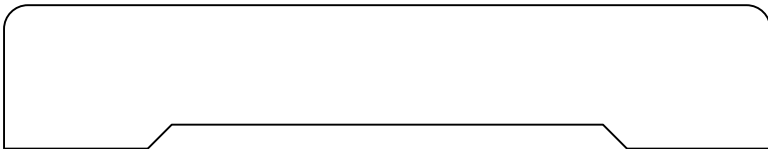

# Craftsman

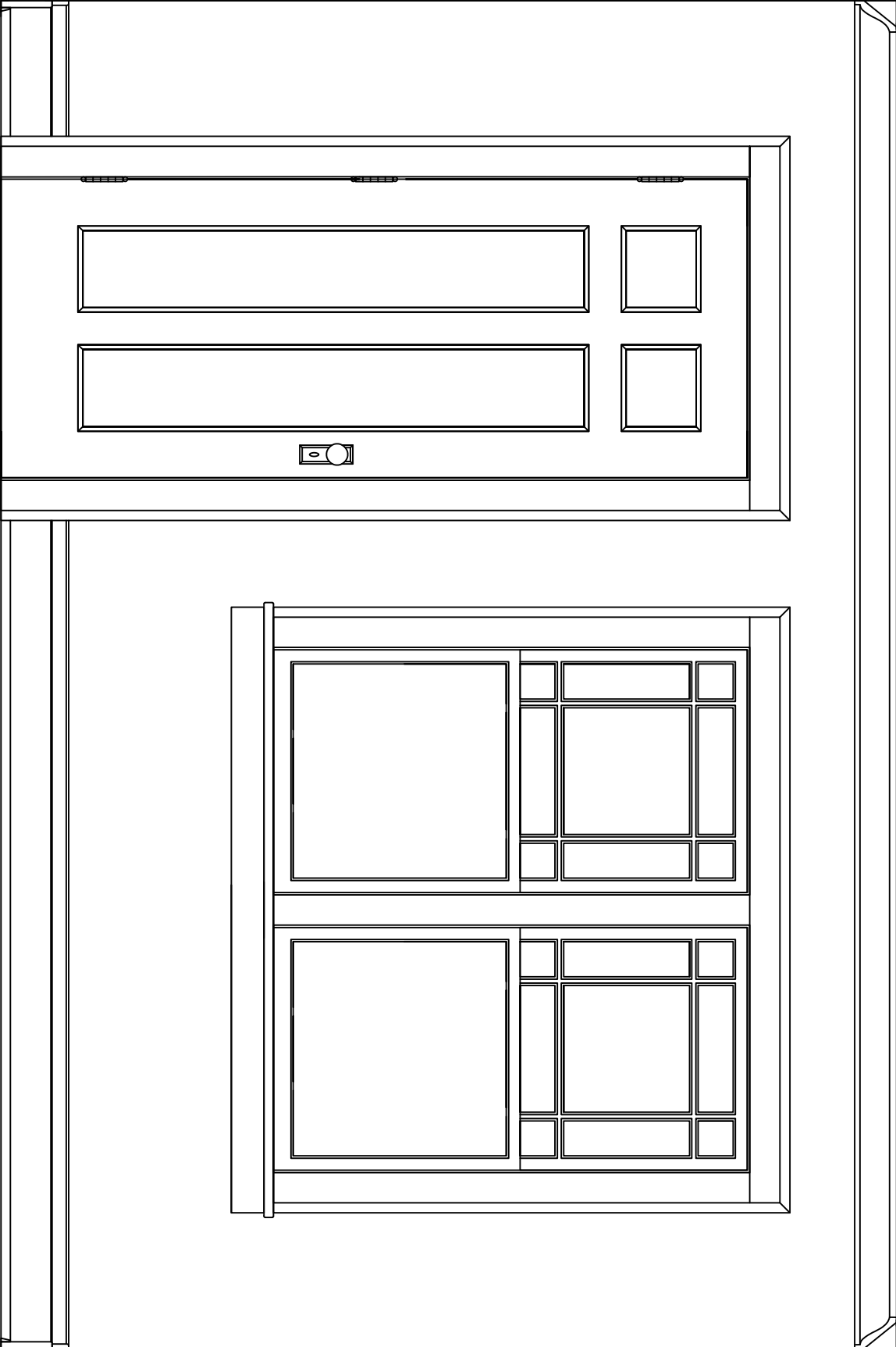

# Craftsman

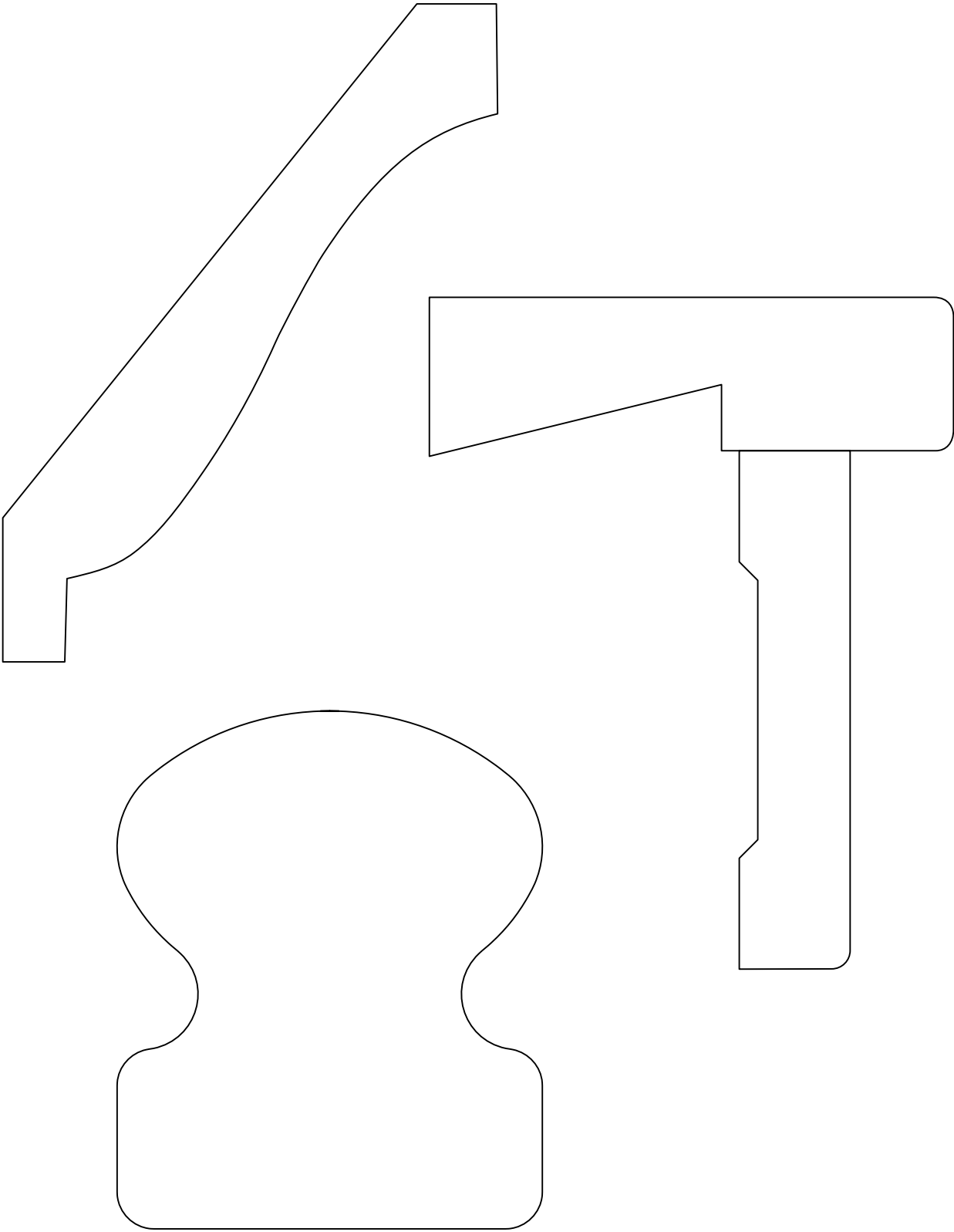

# Craftsman

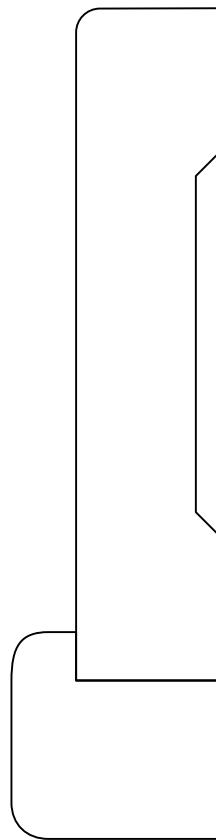
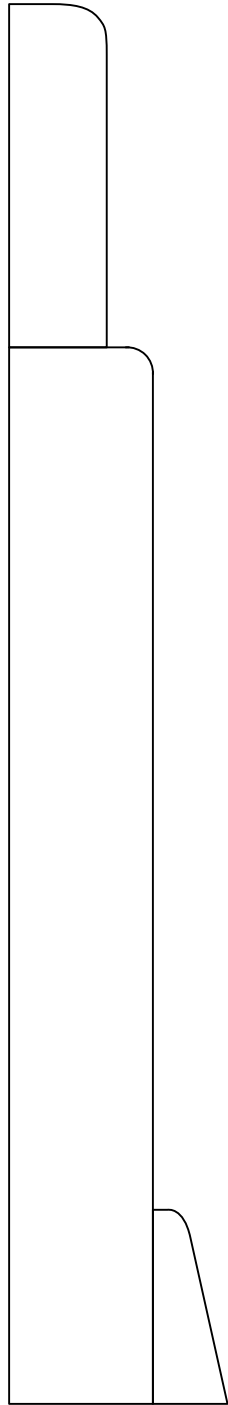

# Craftsman



CR 1269 - .875 x 1.813

DM 9- .375 x 1.125

S4S - .375 x 1

CR 1262 - .75 x 3.5

SM 35 - .375 x 1

# Craftsman



S4S - .75 x 5.5



E1E - .75 x 5.5

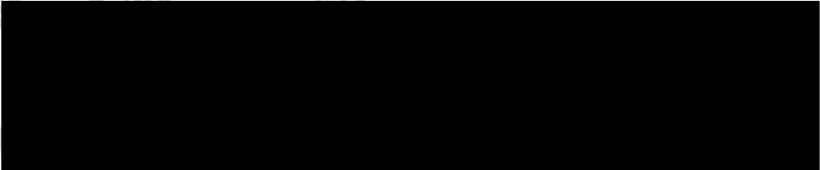

S4S - .75 x 4.25



E2E - .75 x 4



S 20 - 1.125 x 3.5



S4S - .75 x 4

# Craftsman



C 394 - .563 x 4.25

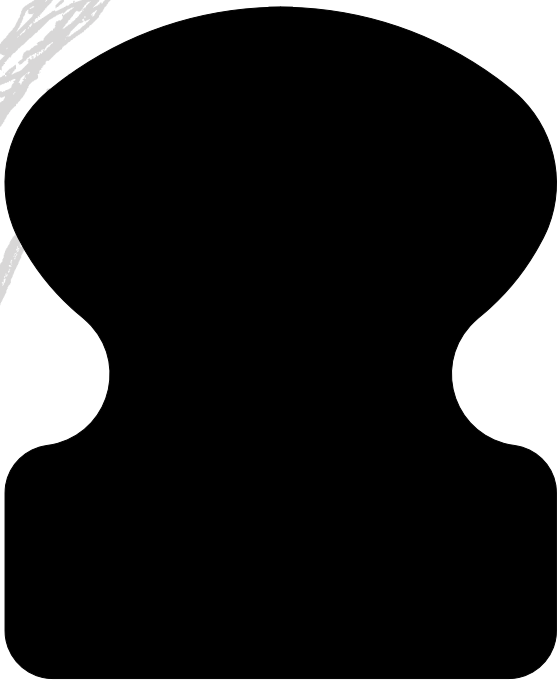

HR 66 - 3.5 x 2.875  
Craftsman/Pellicano



# Craftsman



CR 33 - .906 x 5.5



SM 35 - .375 x 1



E1E - .5 x 1.75

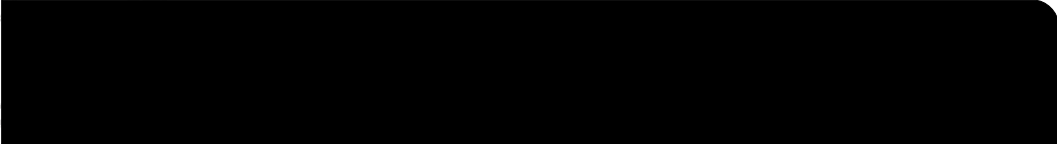

E1E - .75 x 5.5

# Craftsman



E1E - .75 x 3.5



BB 158 - 1.063 \*\* x 1.063



S 20 - 1.125 x 3.5



E1E - .75 x 3.5

# Craftsman

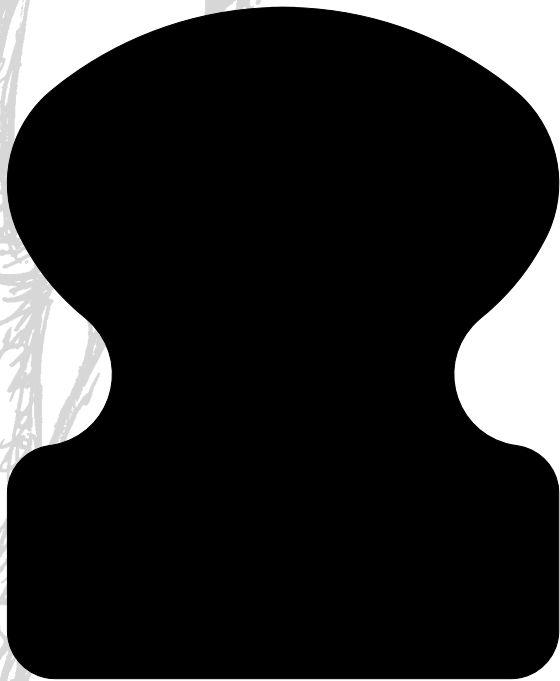

HR 66 - 3.5 x 2.875  
Craftsman/Pellicano

# Federal

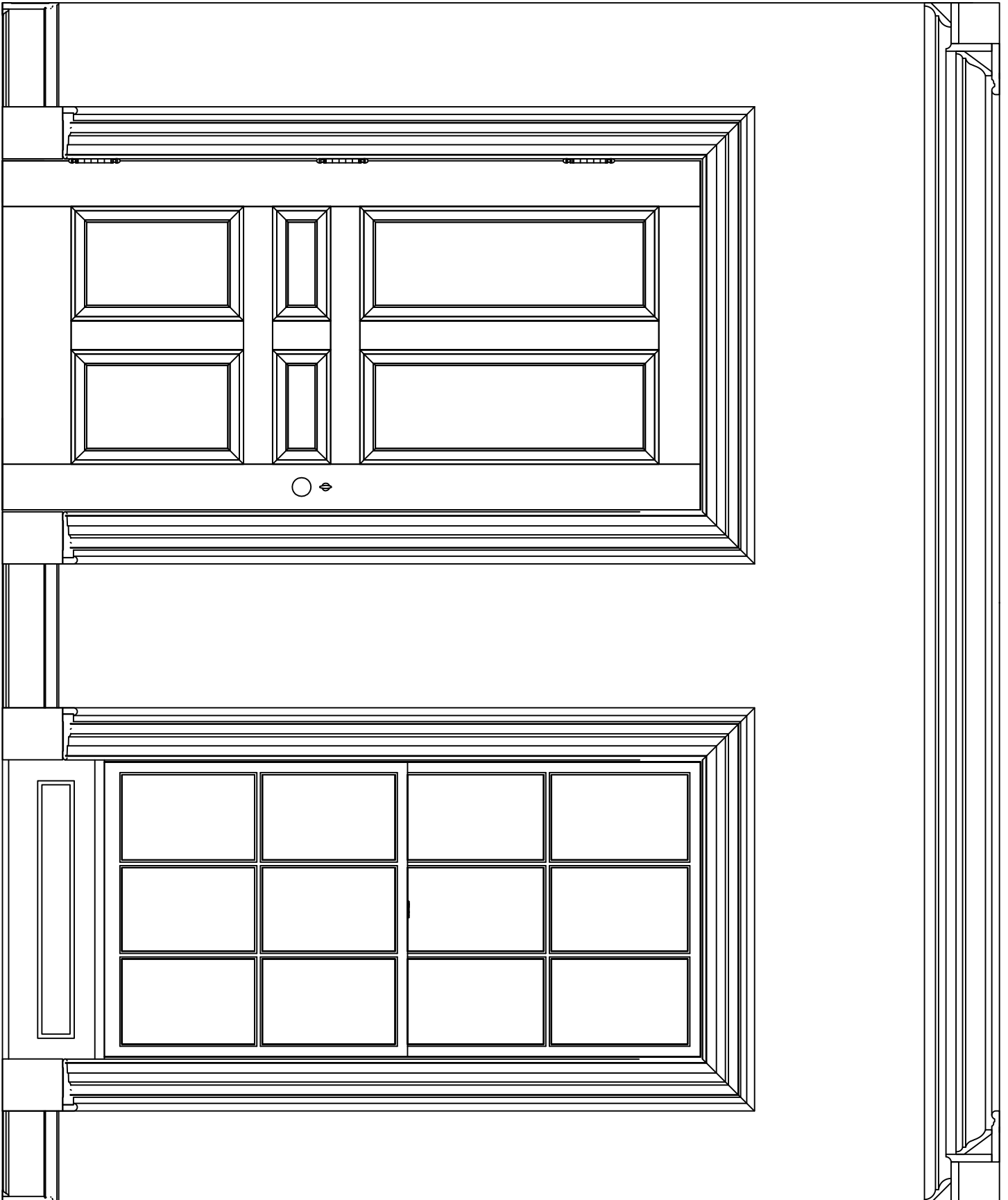

# Federal

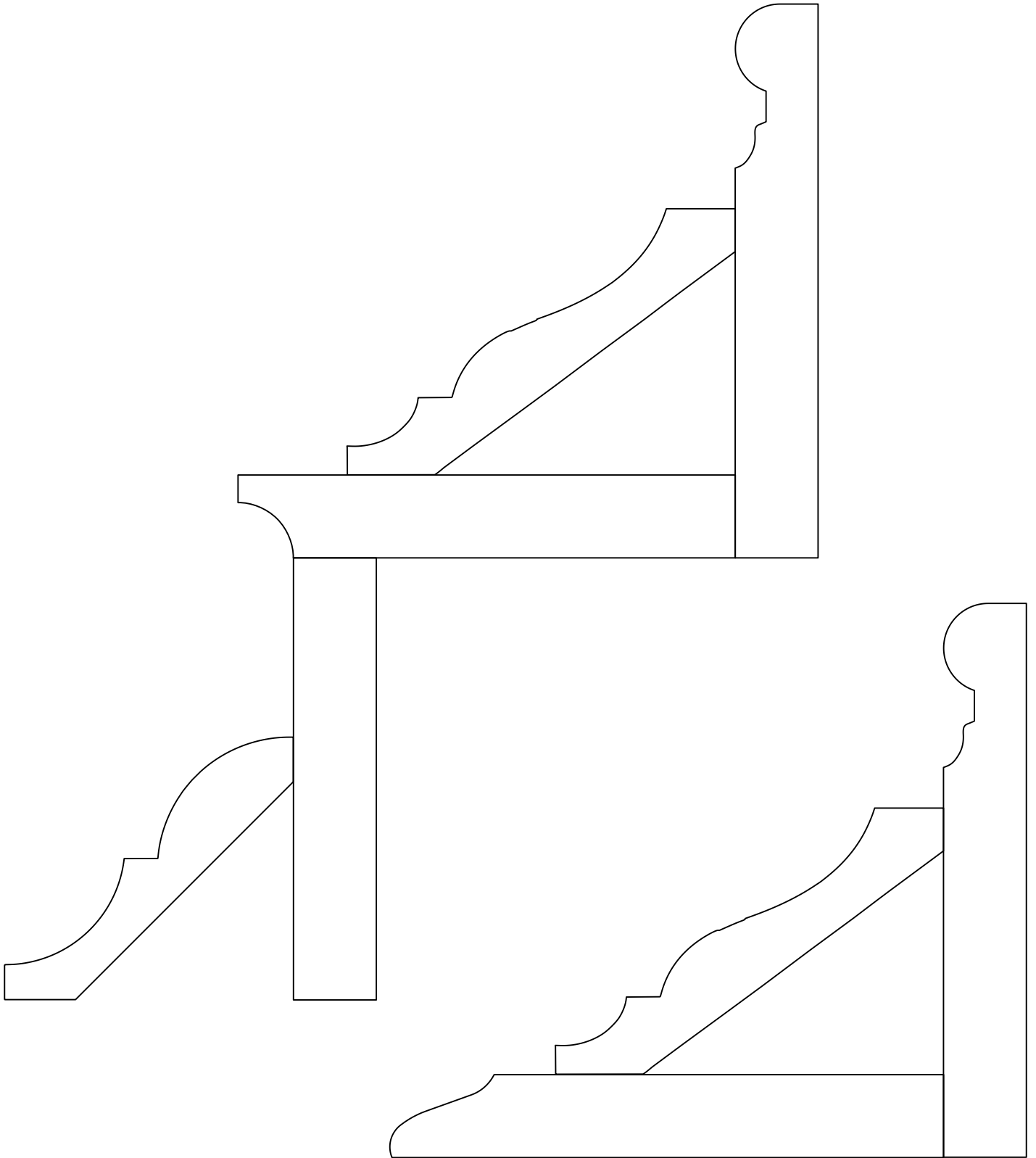

# Federal

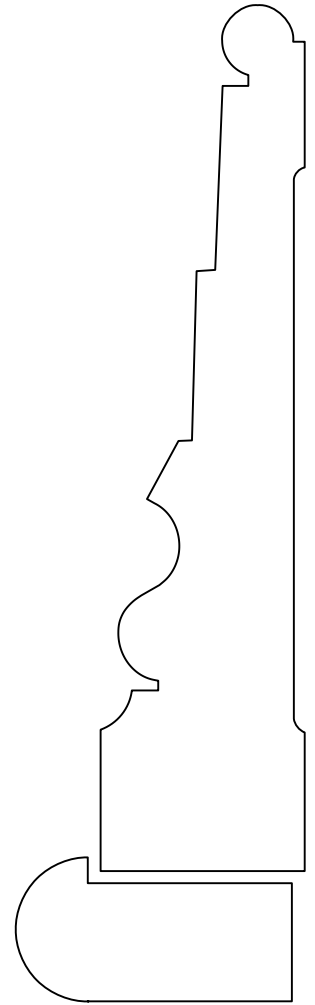
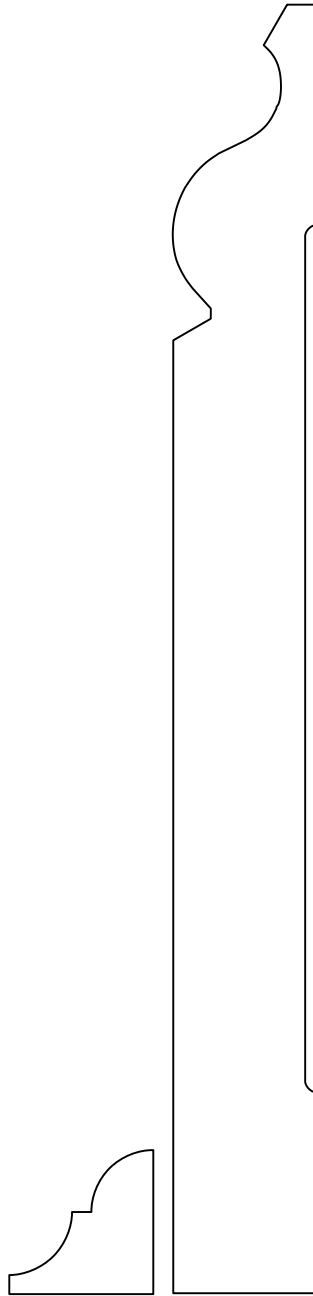
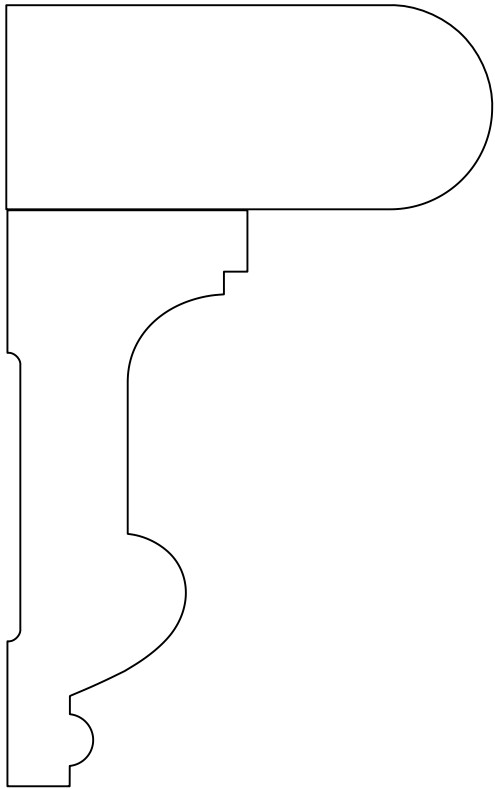
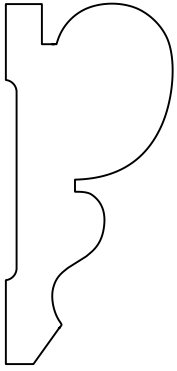
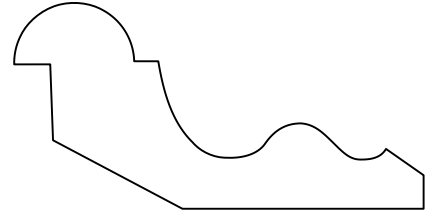

# Federal

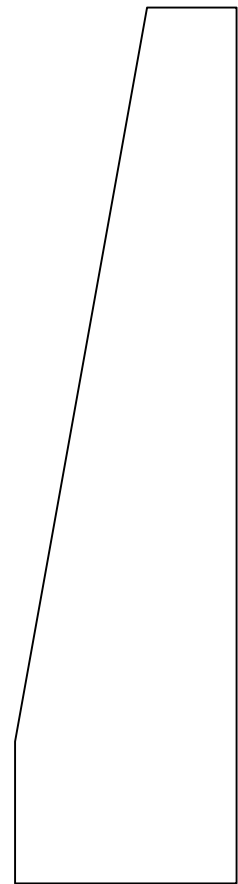
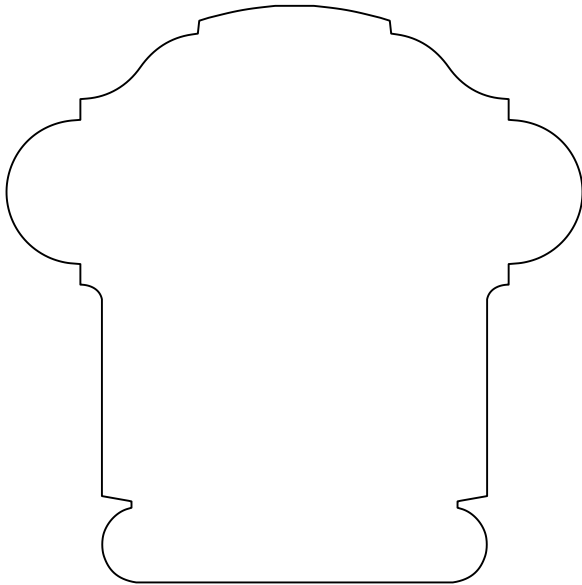
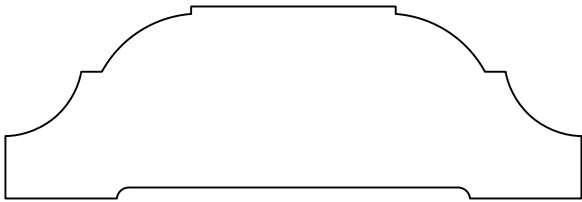
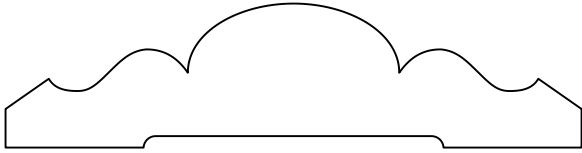

# Federal



B124 - .75 x 6.75 \*\*\*



B 480 - .75 x 4.5 \*\*\*



CR 208 - .75 x 5 \*\*\*



B 20 - .75 x 7 \*\*\*

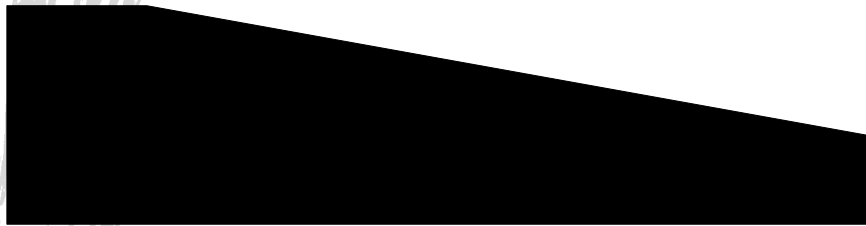

PNTH 64 - 1.125 x 4.5

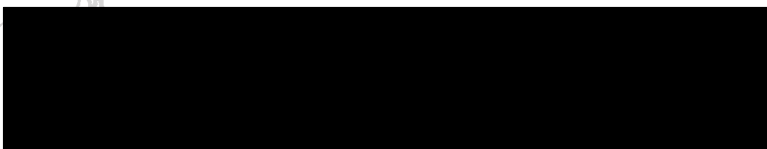

S4S - .75 x 4



# Federal



C 226 1.063 x 4.5



C 8749 1.25 x 3



BN 49 - 1.063 x 2.5

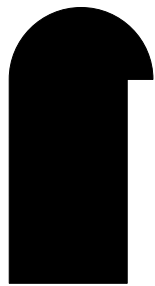

BB 151 - .75 x 1.438



CR 355 - .75 x .75

# Federal



CR 9129 - .75 x 4.25



CR 354 - .563 x 3.5

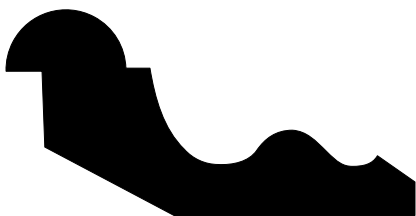

BC 261 - 1.063 x 2.125

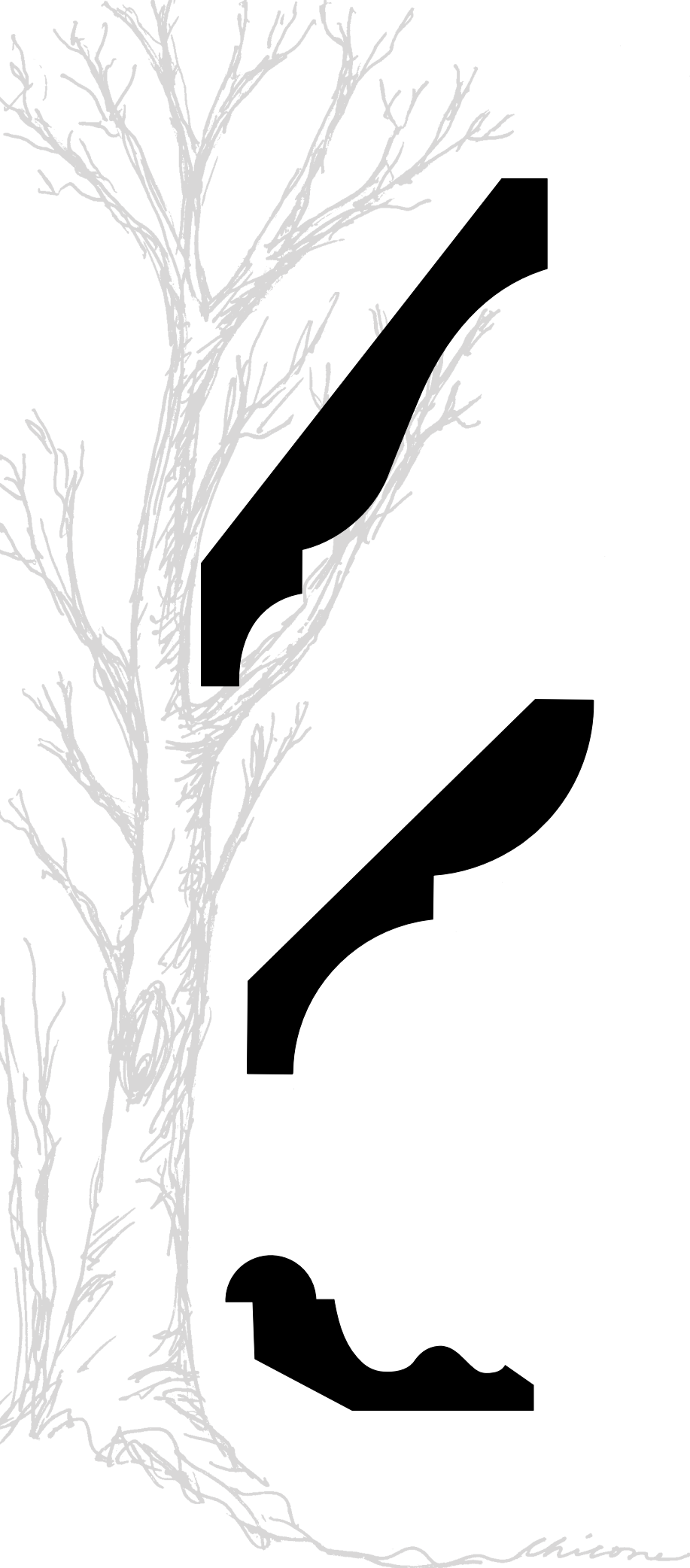

# Federal



PR 11 - .875 x 1.875

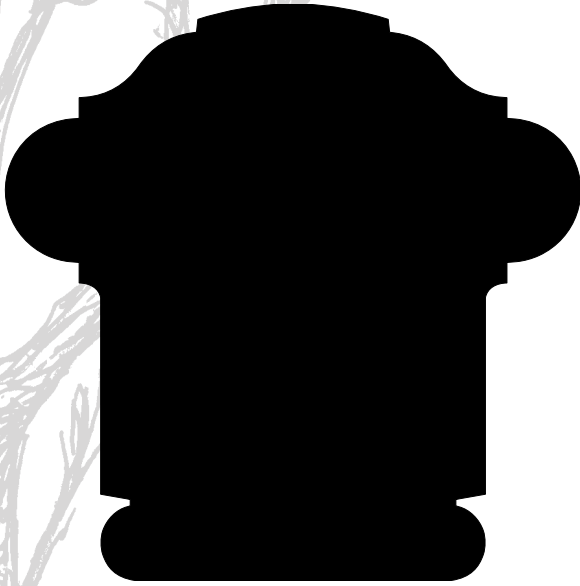

HR 1200 - 3 x 3

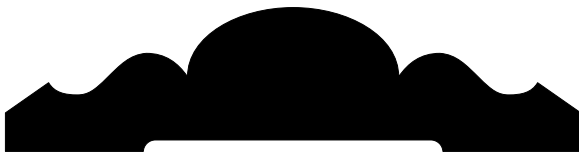

CHR 67 .75 x 3

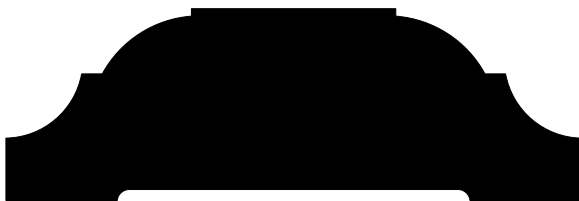

CHR 68 1 x 3

# French Baroque

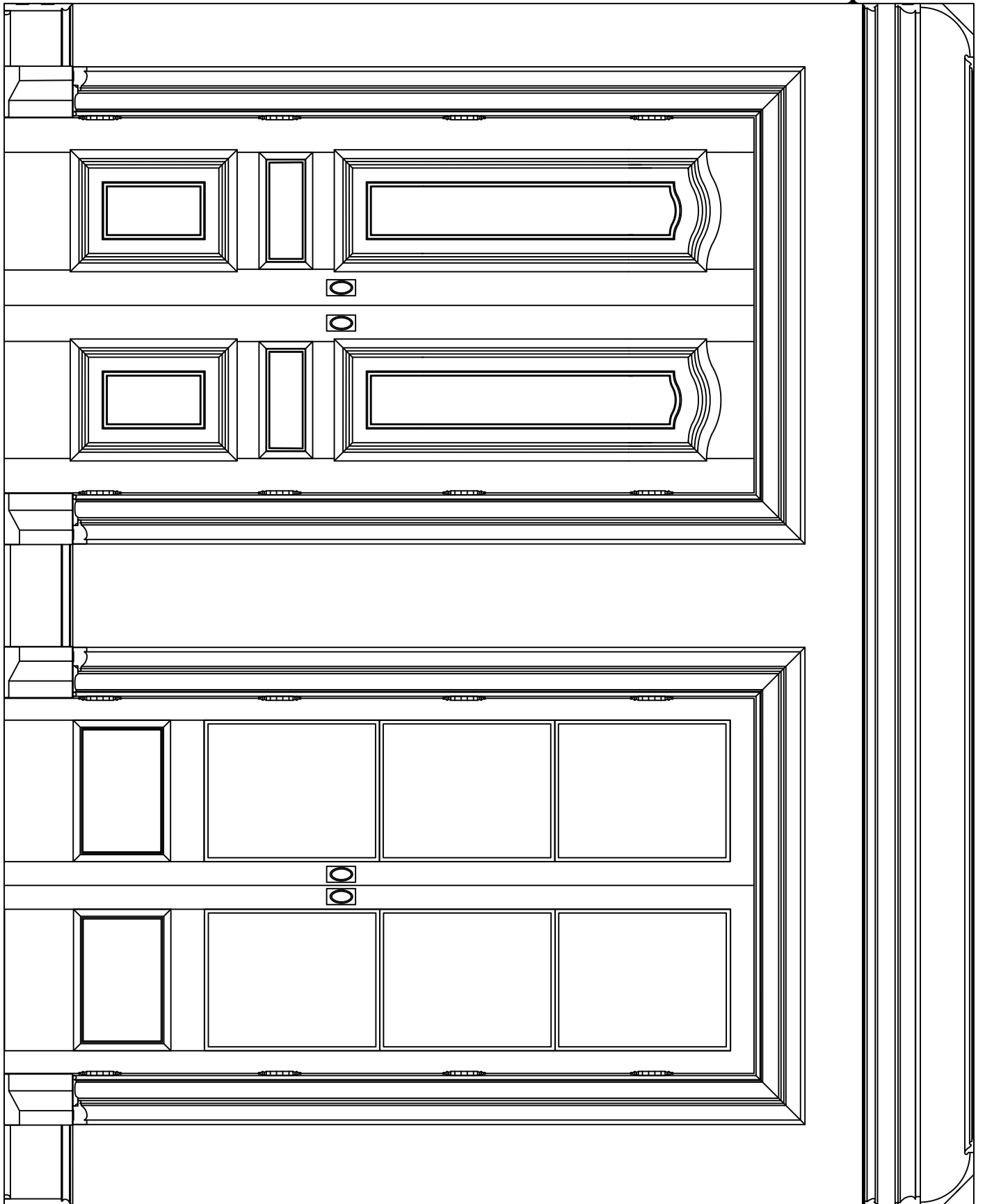

# French Baroque

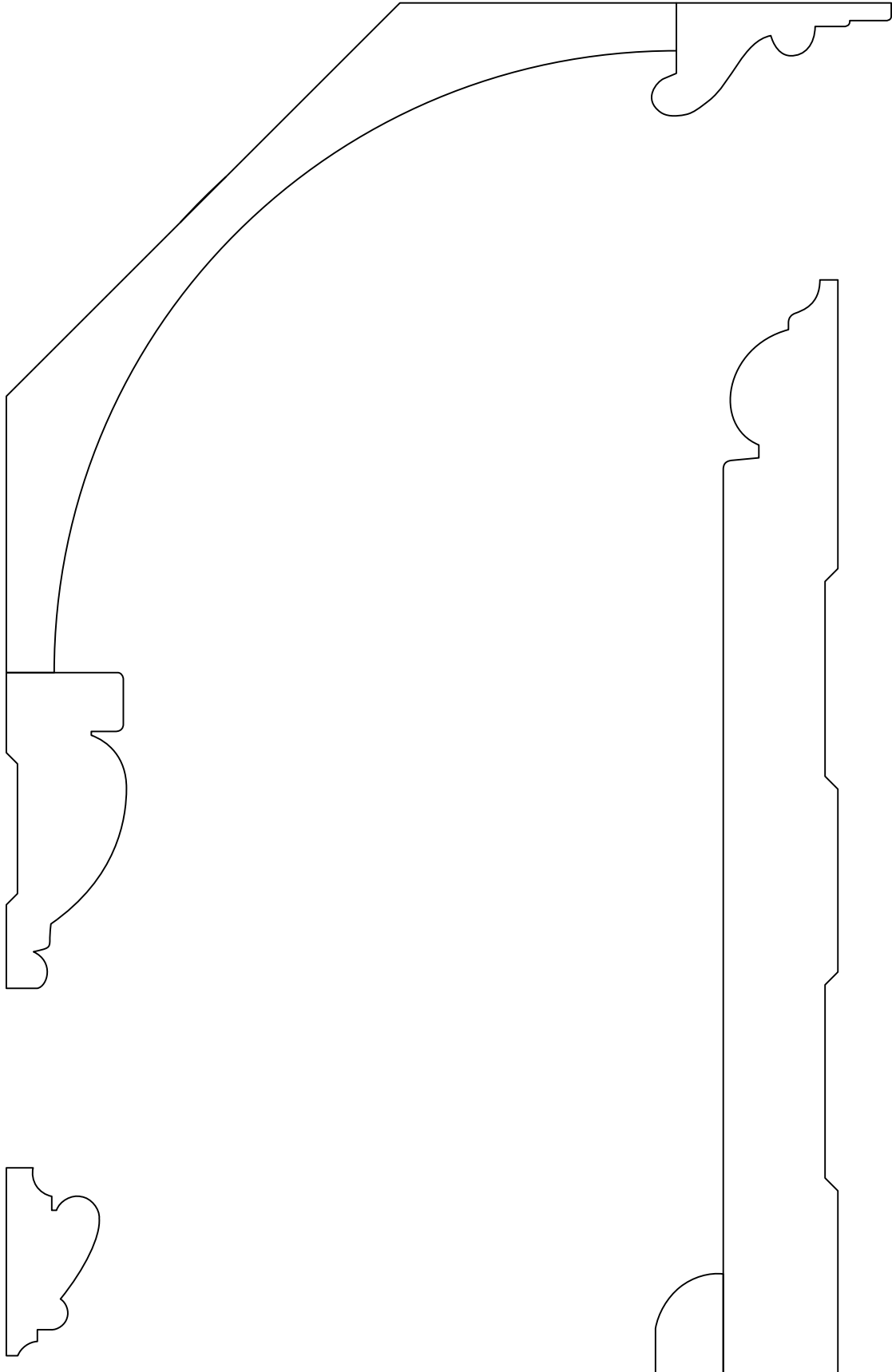

# French Baroque

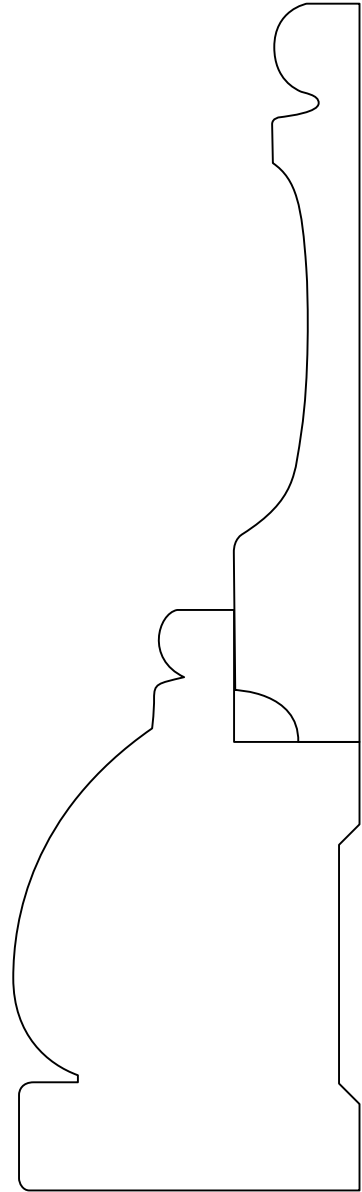
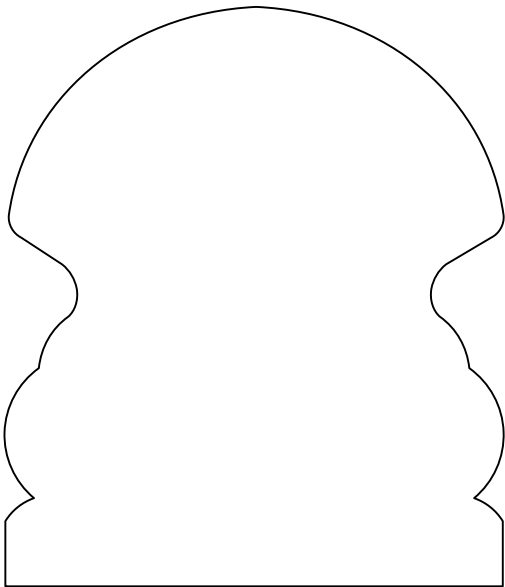
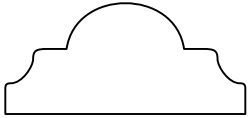

# French Baroque



B 665 - .906 x 8.5 \*\*\*



PL 61 - 1.938 x 6.5



C 8851 - .625 x 3.875

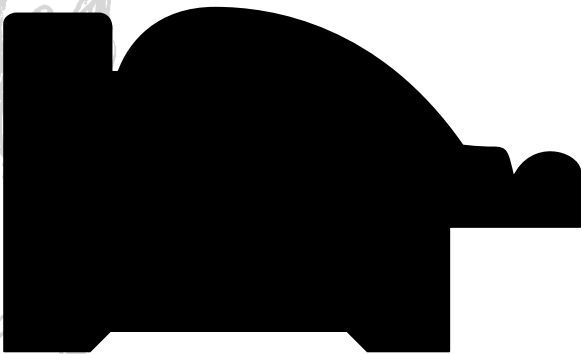

BB 157 - 1.75 \*\*\* x 3



AST 46 - .578 x 1.25

# French Baroque

PR 12 - .875 x 1.813



CV 9000 - 2.125 x 9

*Chicone*



# French Baroque



SM 7 .5 x .75



C 392 - 1.063 x 2.25

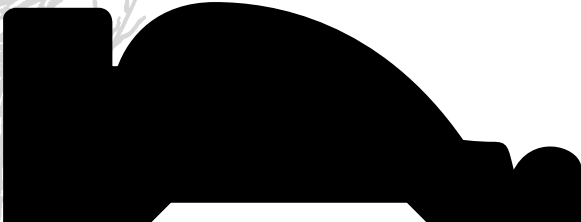

C 393 - 1.125 x 3



HR 82 - 3 x 2.625

# Georgian

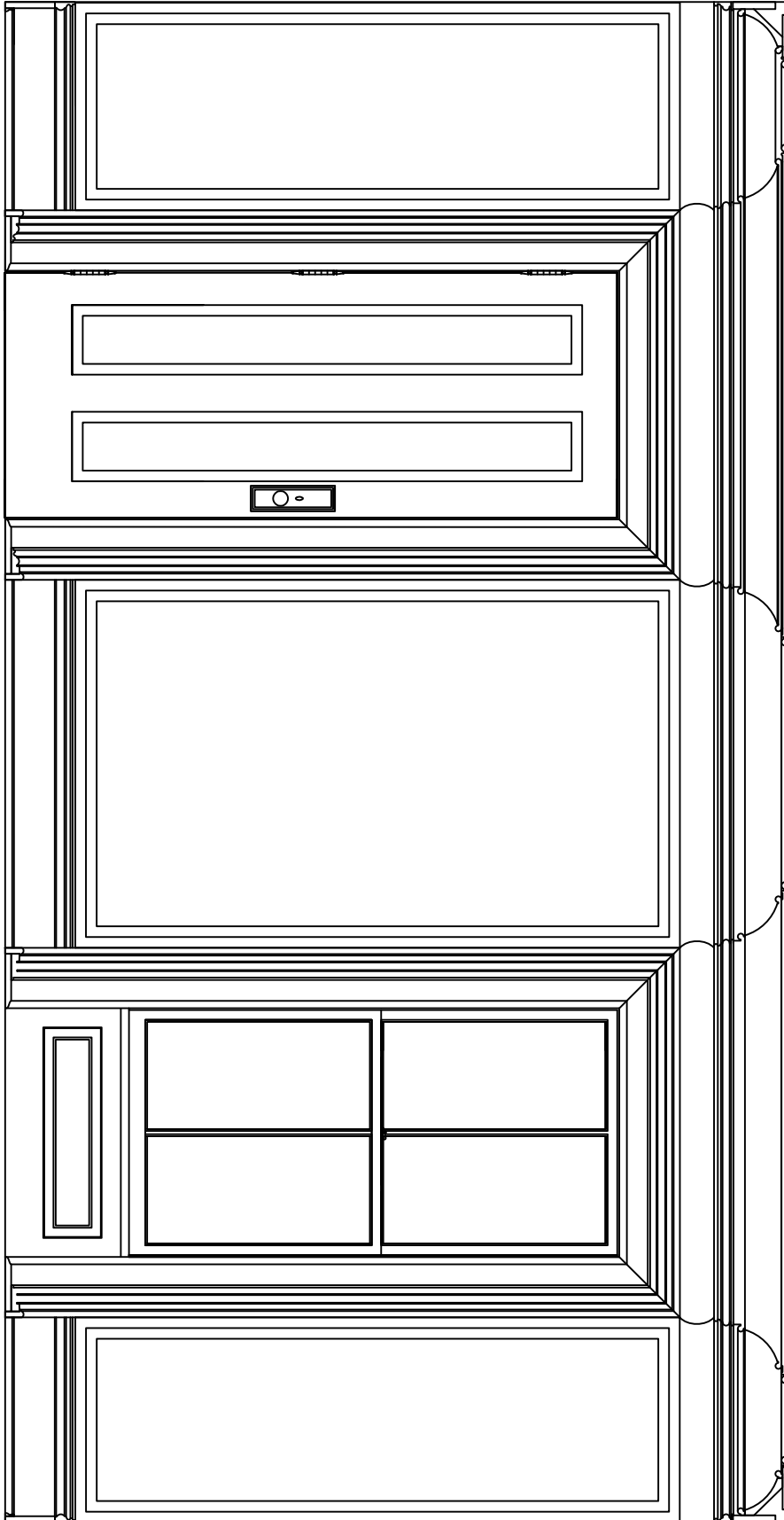

# Georgian

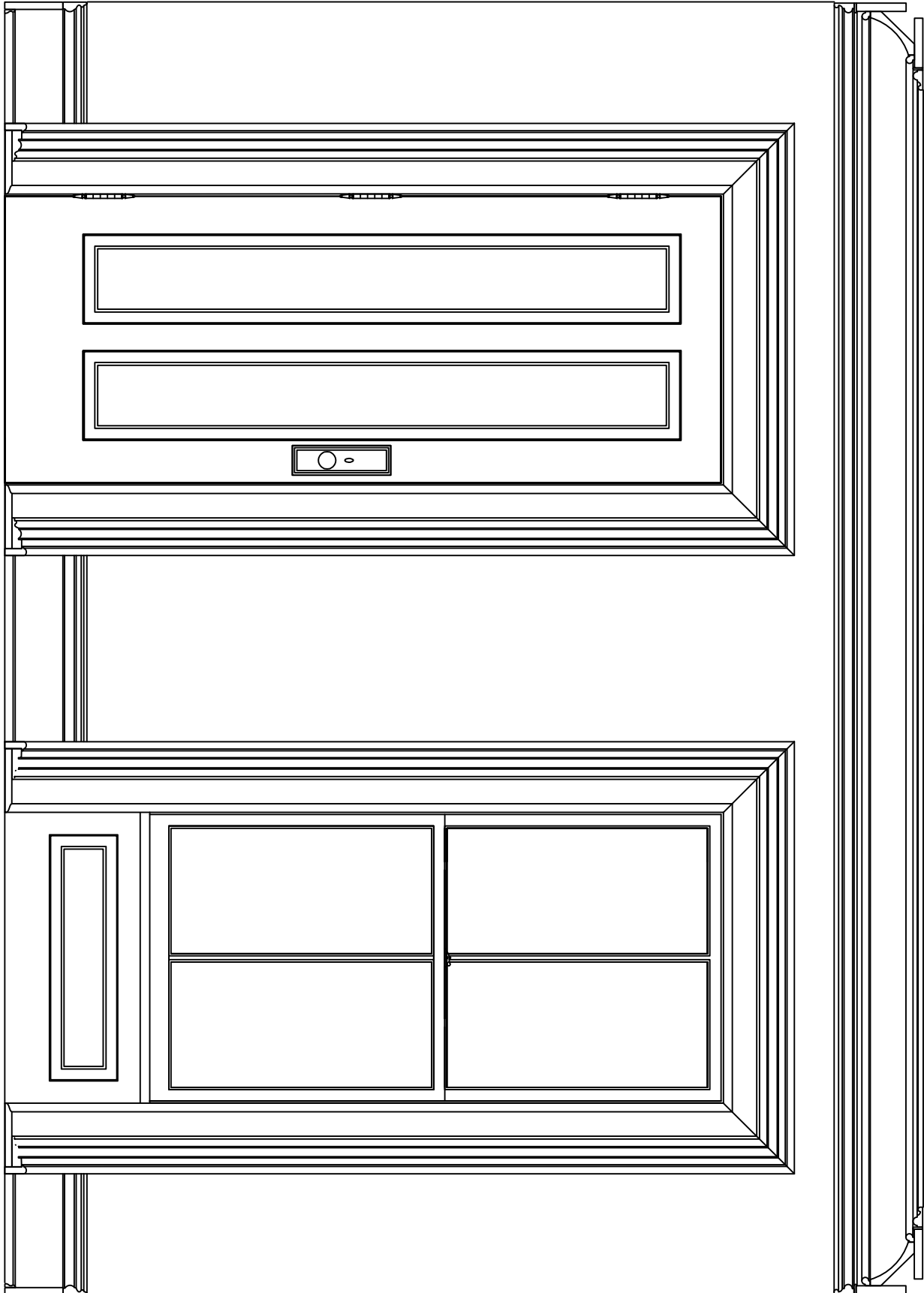

# Georgian

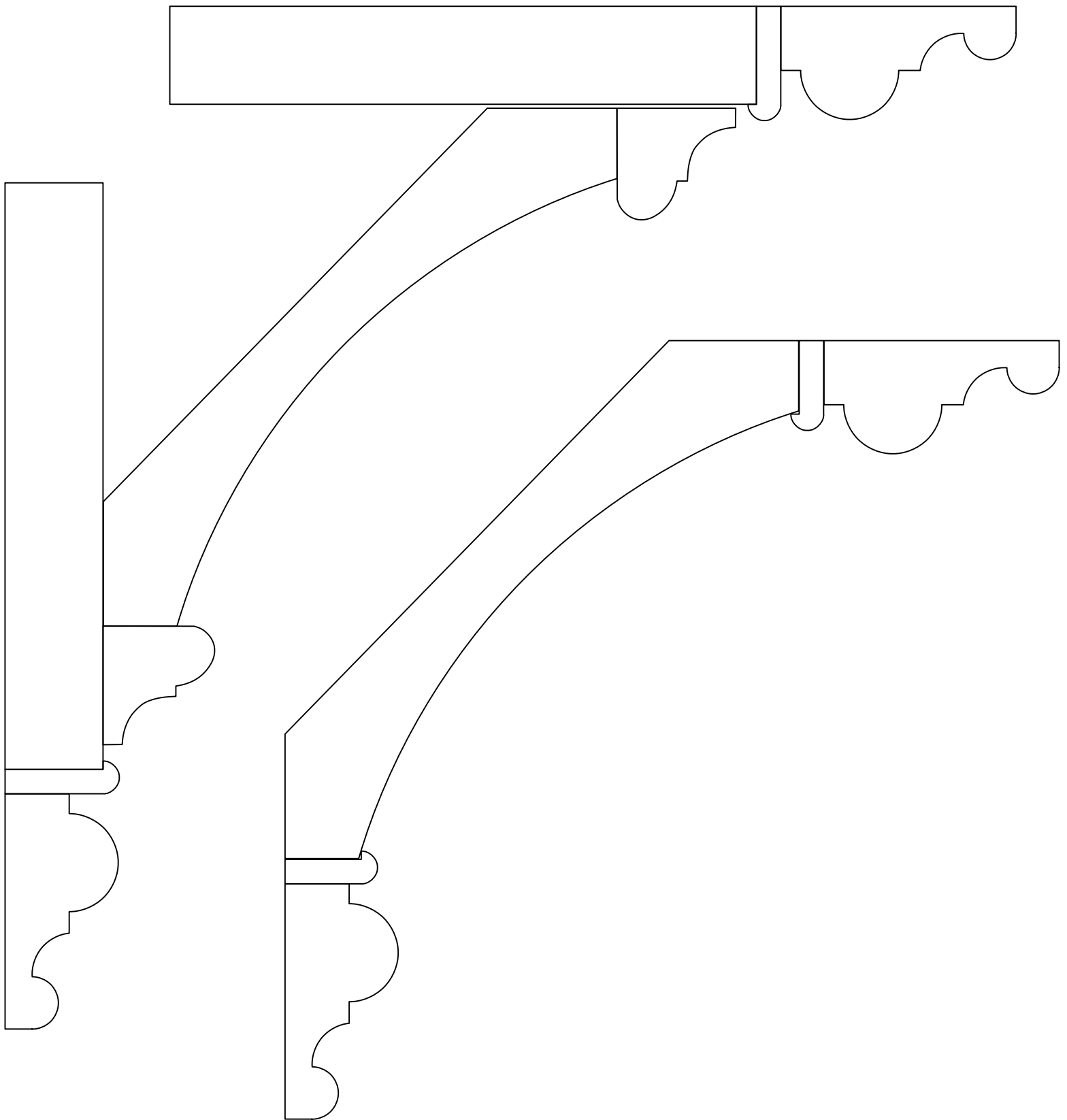

# Georgian

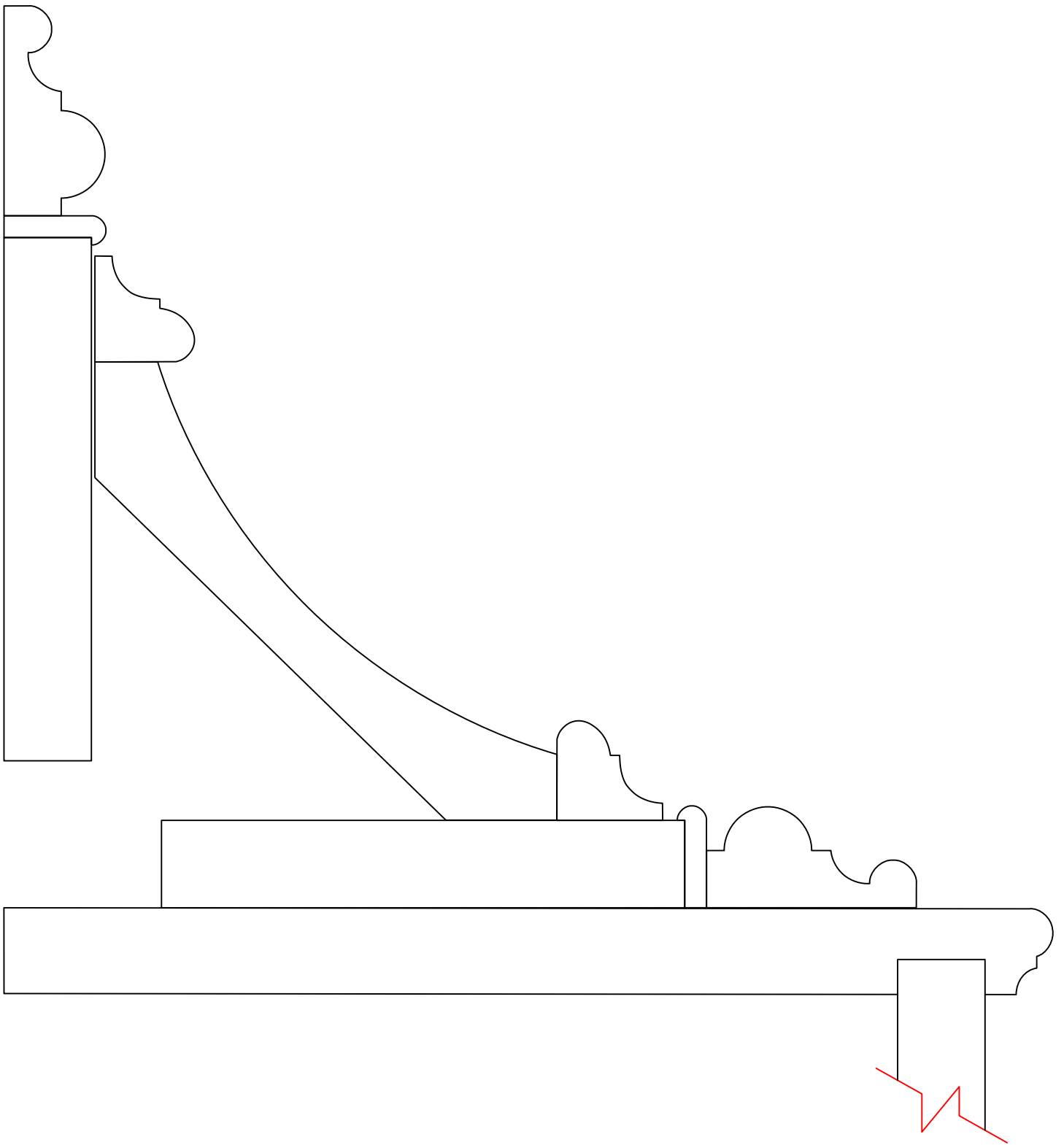

# Georgian

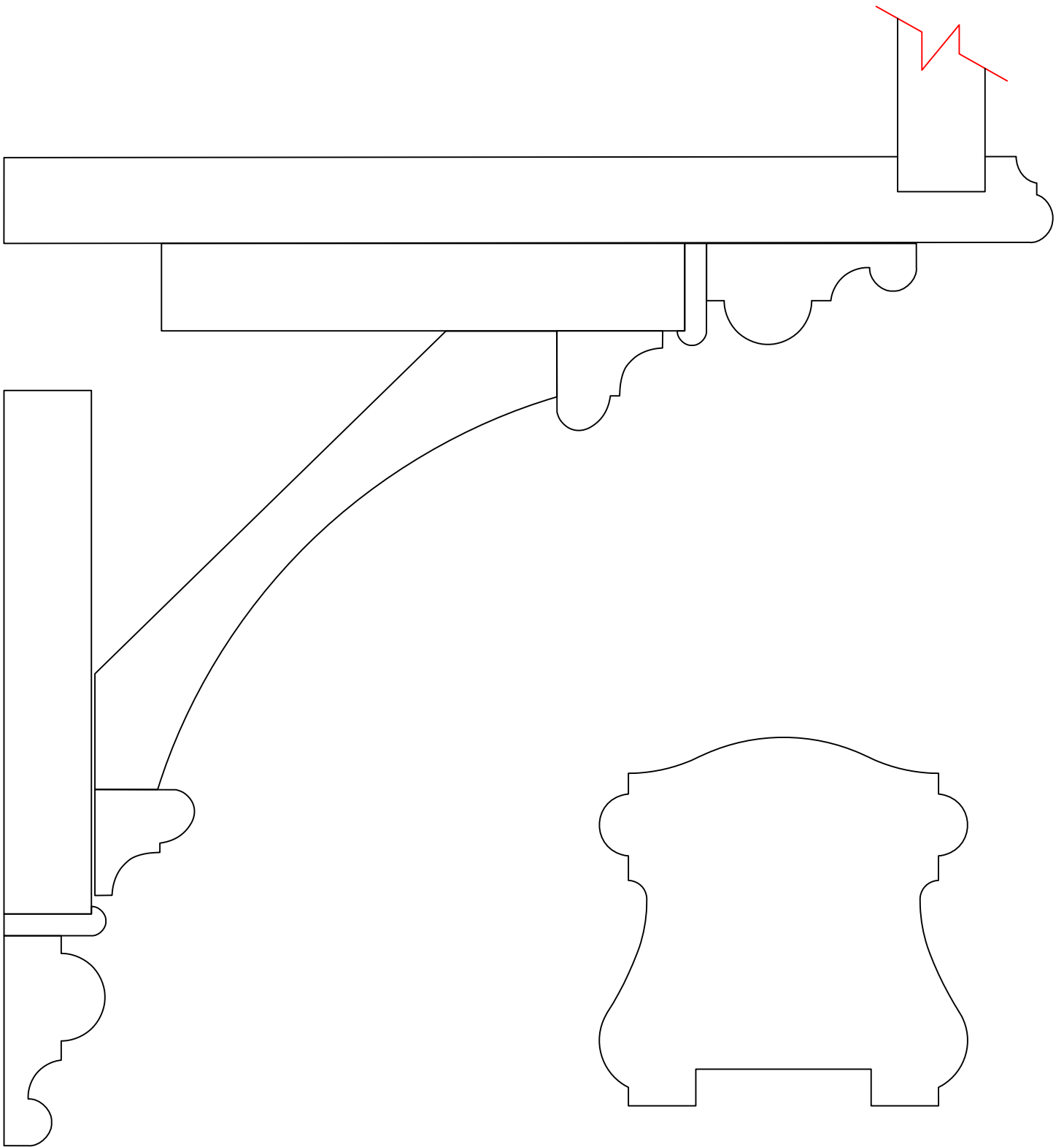

# Georgian

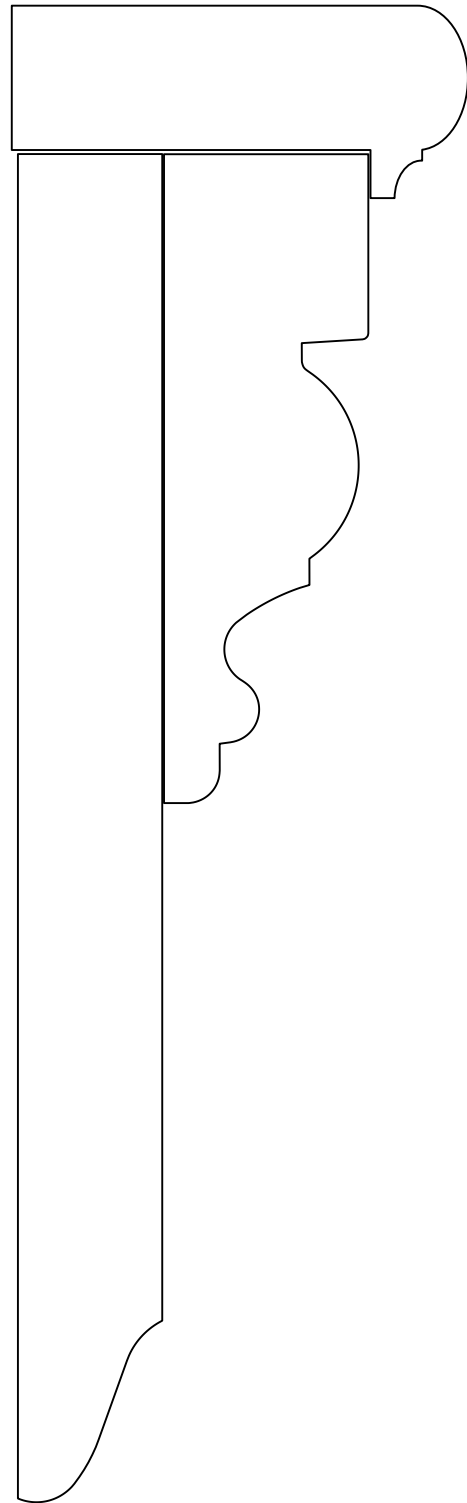
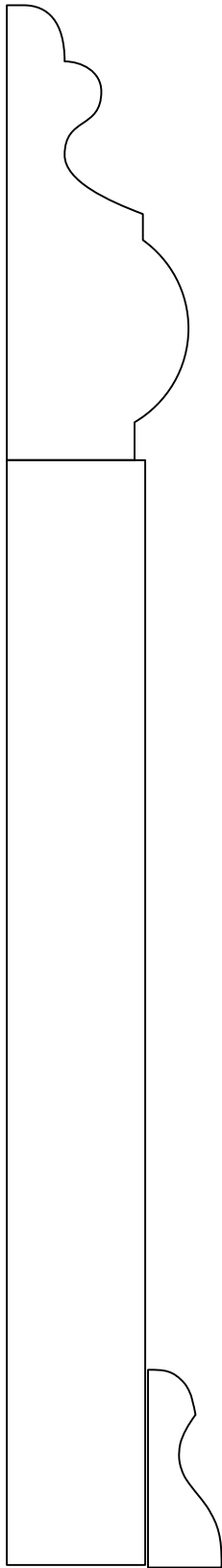

# Georgian

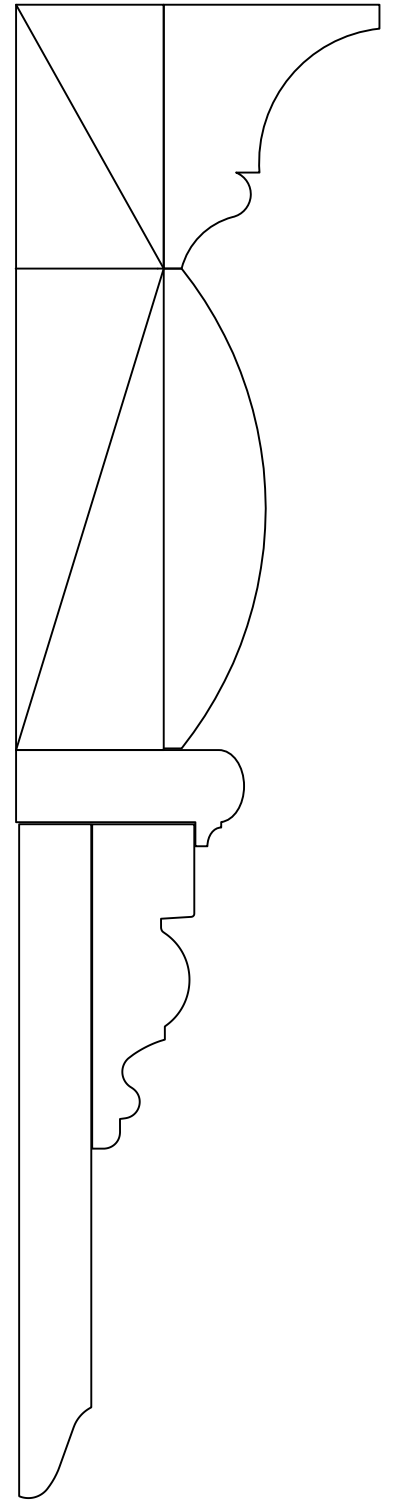
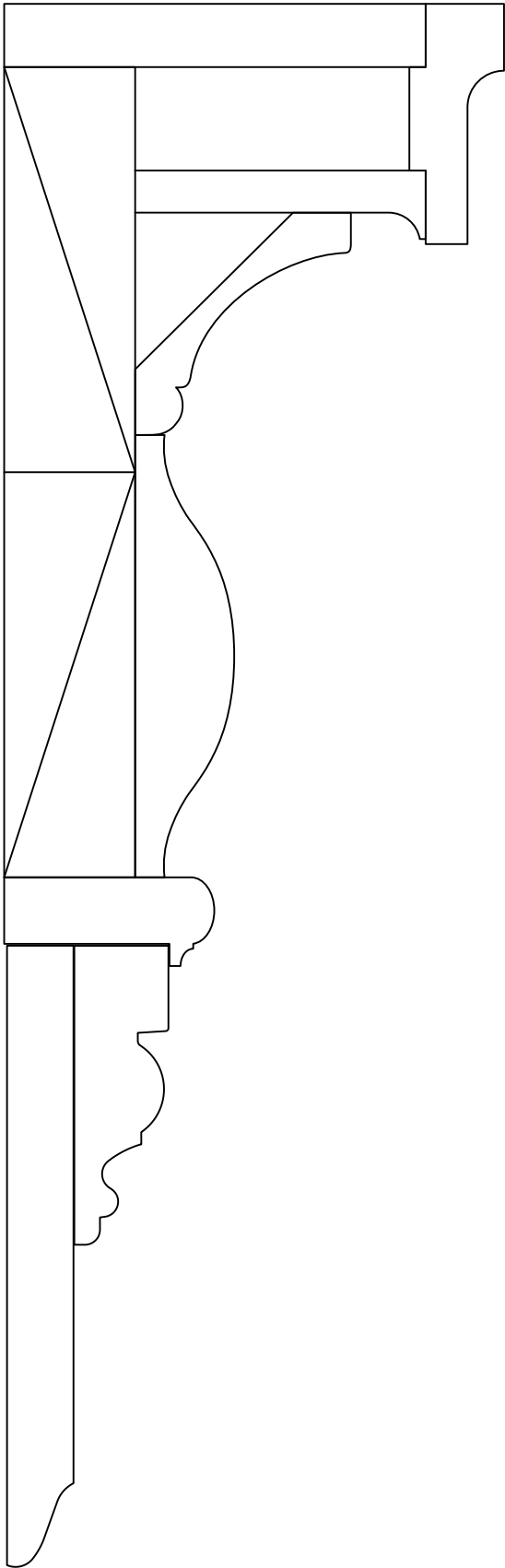



# Georgian

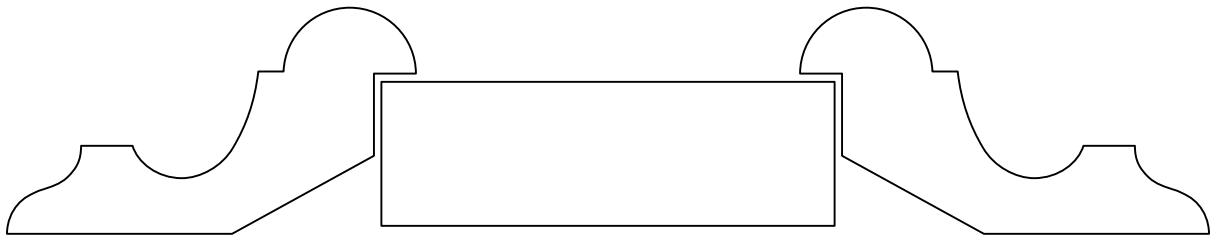
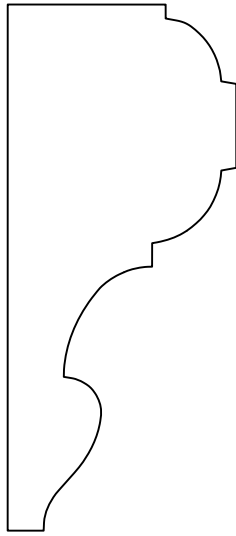
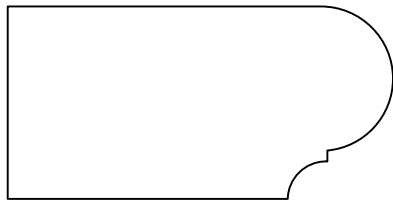
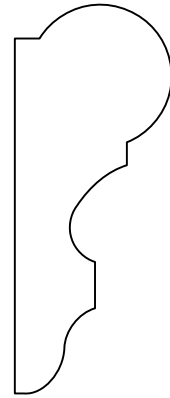
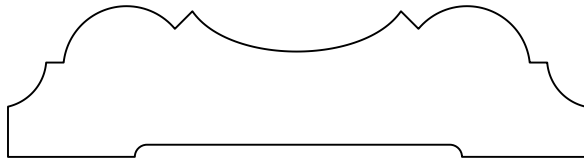

# Georgian

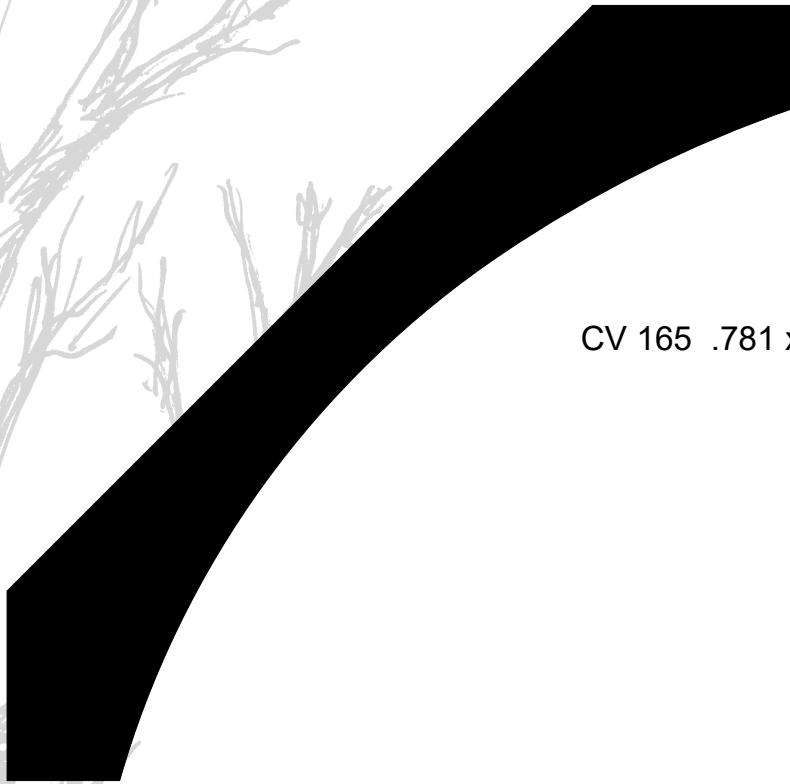

CV 165 .781 x 5.75



DM 39 - .25 x 1

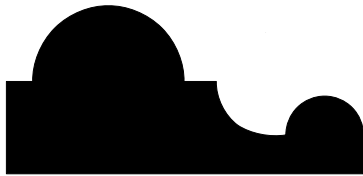

WC 70 - .875 x 1.75

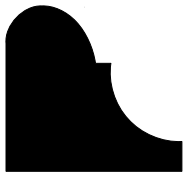

N 14 - .938 x 1



S4S - .75 x 4.5

# Georgian



T 98 - .75 x 7 \*\*\*

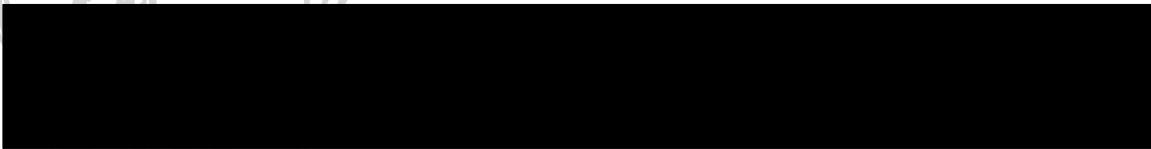

S4S - .75 x 7

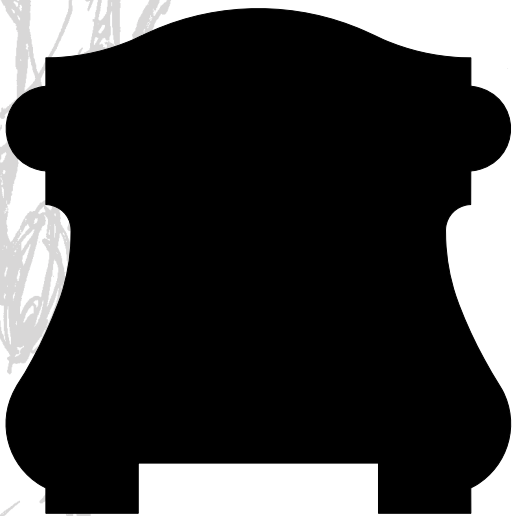

HR 43 - 2.625 x 2.625

# Georgian



C 8758 1 x 3.125



C 8757 1 x 2.875



SM 19 .5 x .75

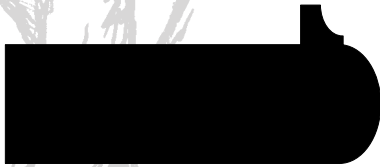

BB 150 - 1 x 2.375



B 20 - .75 x 7 \*\*\*

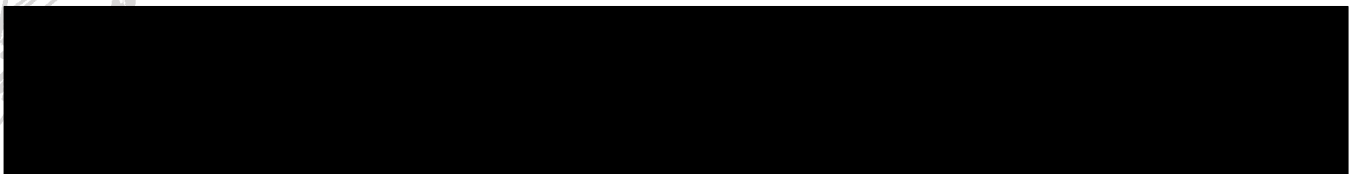

S4S - .875 x 7

# Georgian



CR 1221 - 2.25 x 2.75



CR 1267 - 1.063 x 2.75

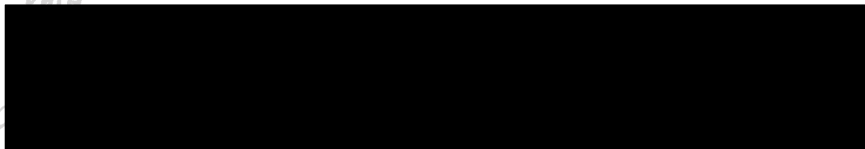

S4S - .75 x 4.5



CR 1264 - .75 x 4.5

# Georgian



M 7 1.125 x 5

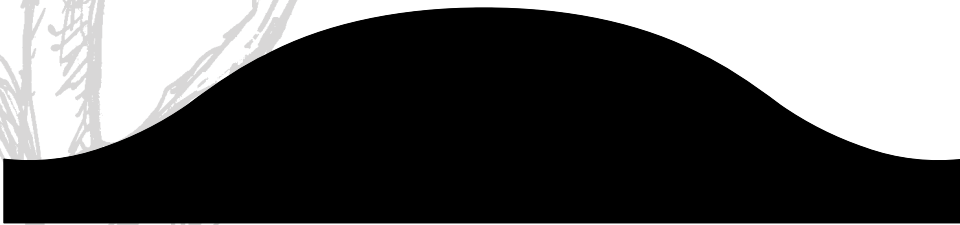

M 6a - 1.125 x 5



CR 1262 - .75 x 3.5

# Georgian



CHR 70 .75 x 3



PR 13 - .75 x 2



BC 111 - .75 x 2.125

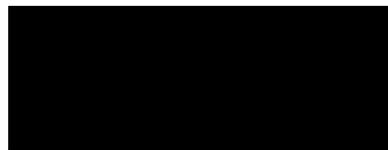

S4S - .75 x 2



N 12 - 1 x 2

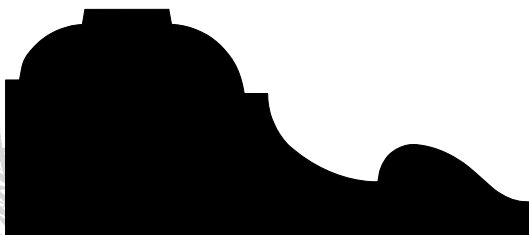

WC 87 - 1.188 x 2.813

# Italiante

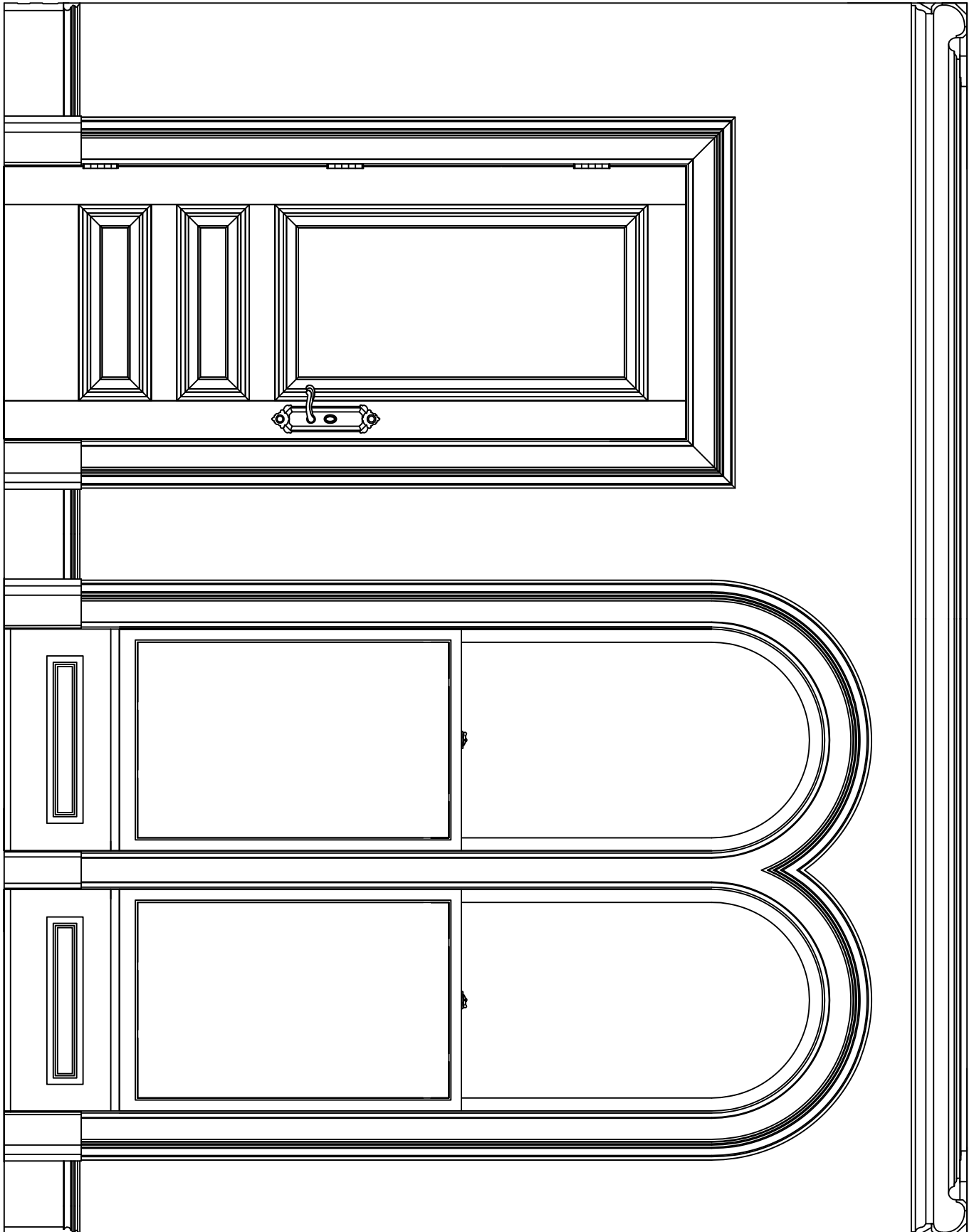



# Italiante

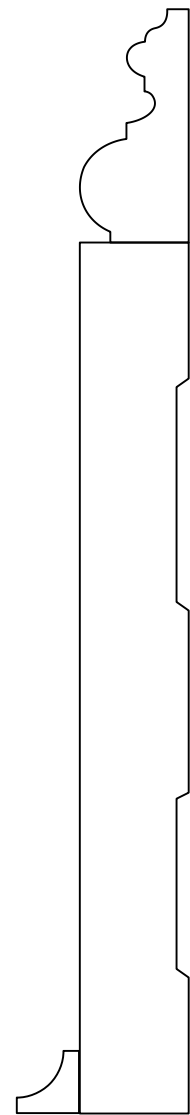
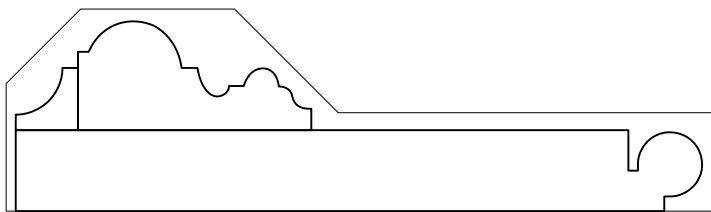
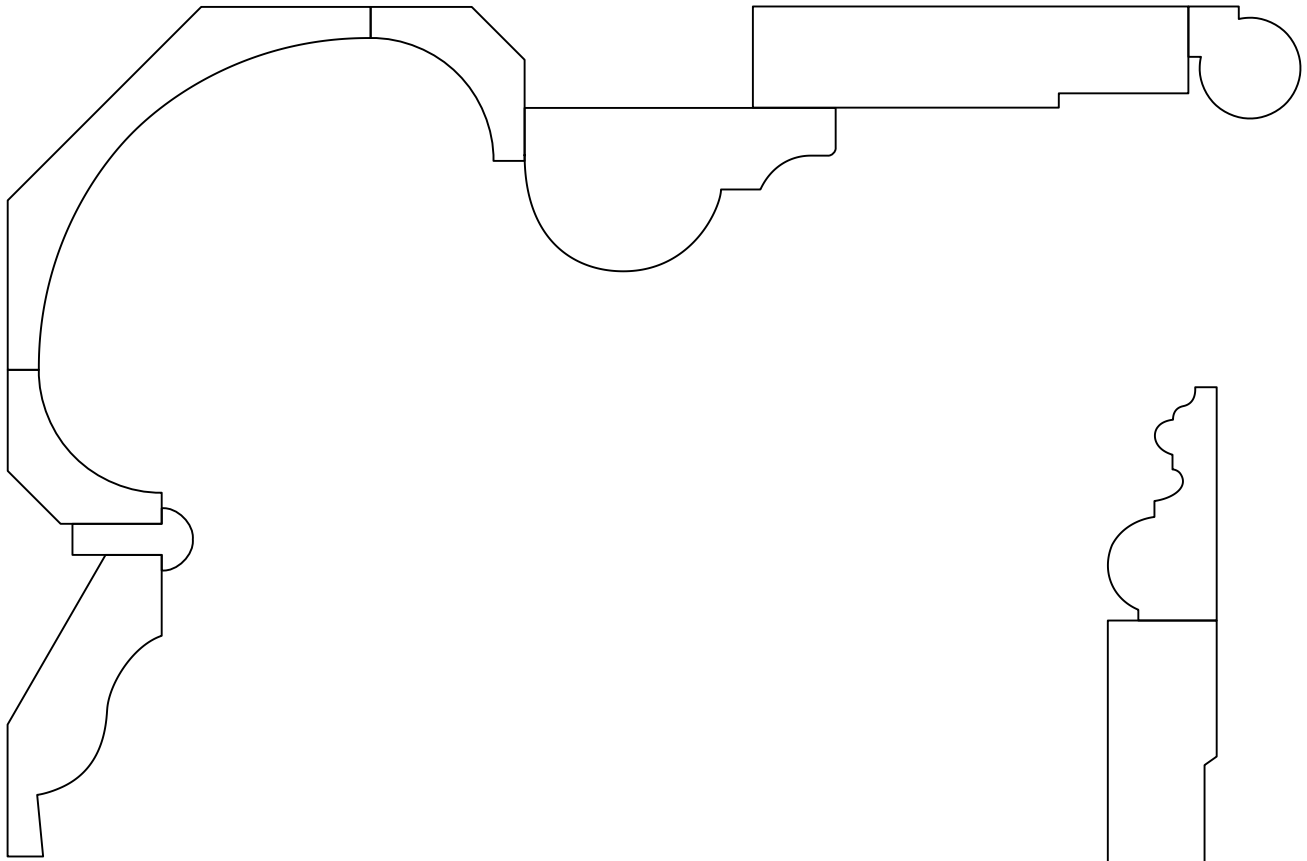

# Italiante

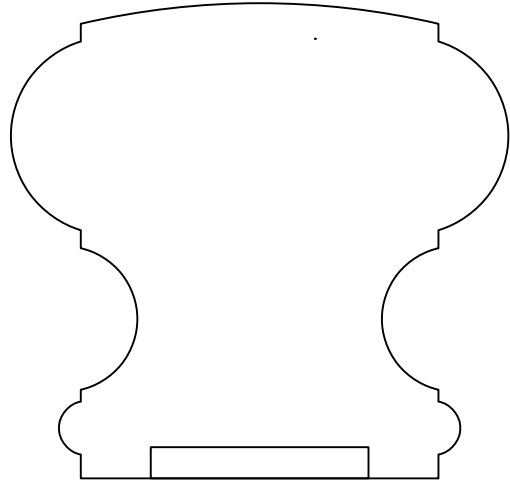
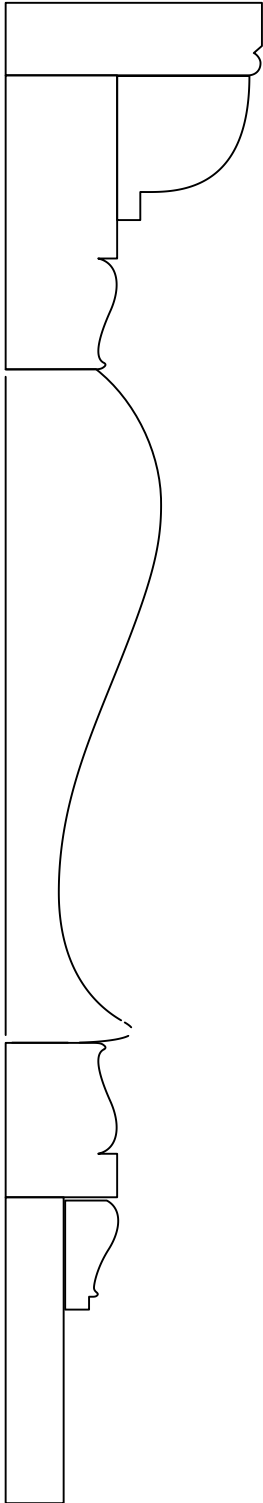

# Italiante



BC187 - .75 x 1.688



CV 050 .5 x .5

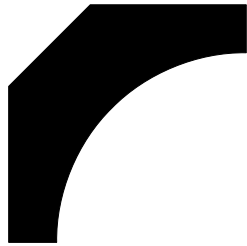

CV 135 - .75 x 1.75

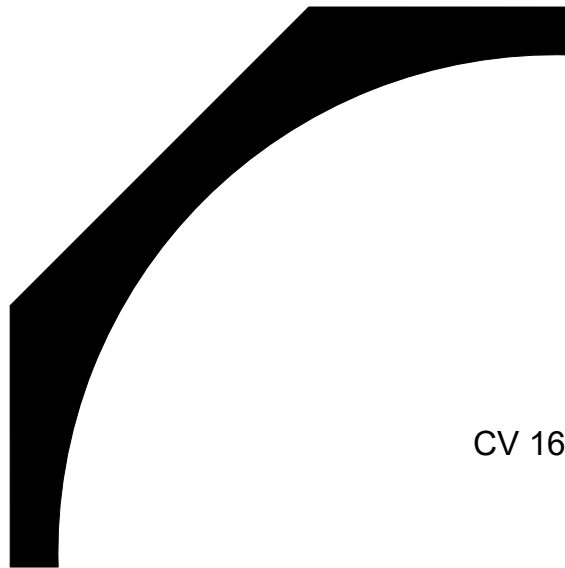

CV 168 - 1.40 x 4.125



DM 37 - .5 x 1



# Italiane



CR 102a - .770 x 2.718

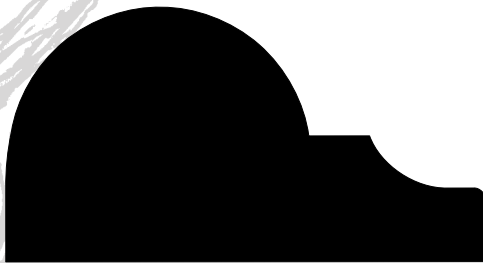

N 103 - 1.313 x 2.5



B 658 - .875 x 2.375 \*\*\*

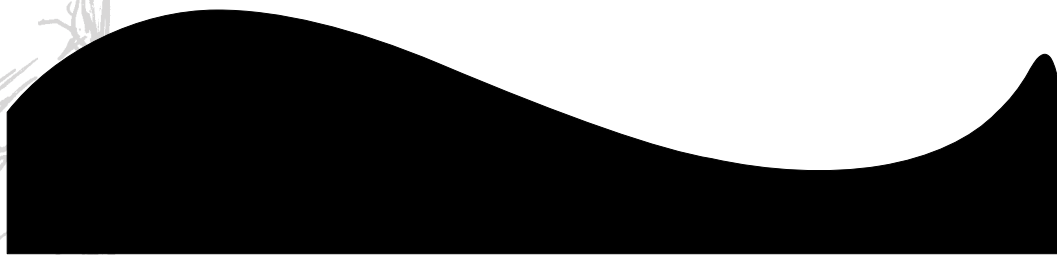

M 10 - 1.25 x 5.5

# Italiante

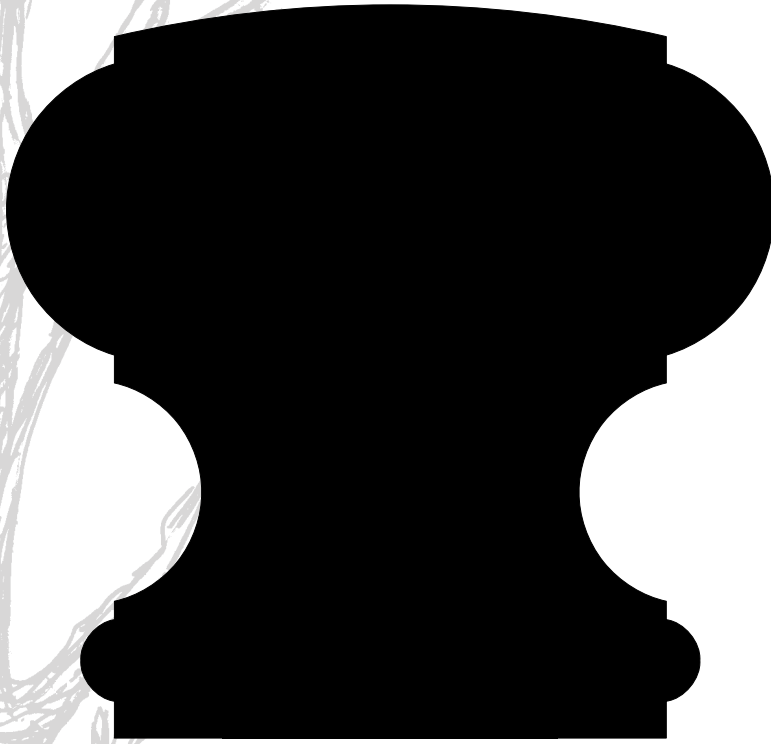

HR 40 - 3.625 x 3.813

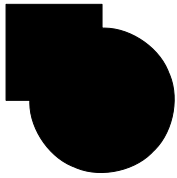

CR 152a - .875 x .875

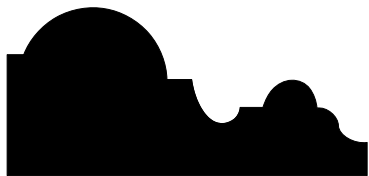

BC 107 - .875 x 1.875



B 658 - .875 x 1.25 \*\*\*

# Italiante

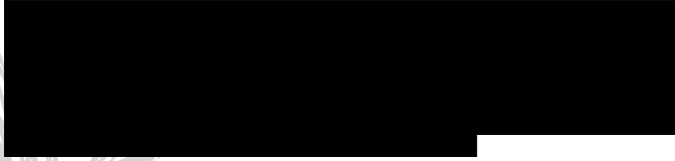

CHR 74 .75 x 3.5



C 244a .75 x 5.5

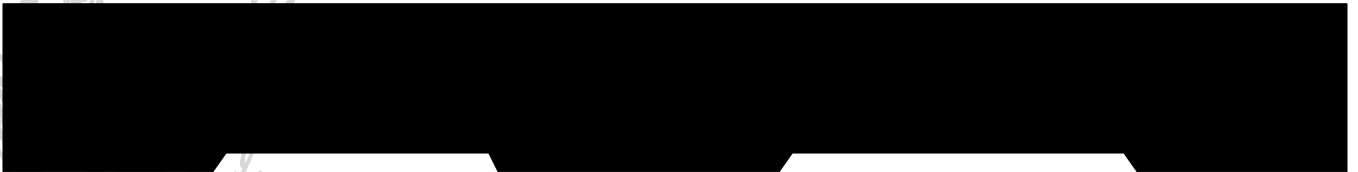

S4S - .875 x 7



BM 24 - .625 x 2.125

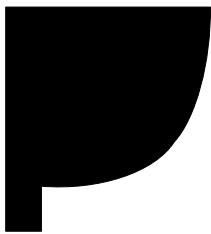

QR 9 - 1.063 x 1.125



S4S - .5 x 2.5

# Italiante

PNTH 66 - 1.625 x 5.75

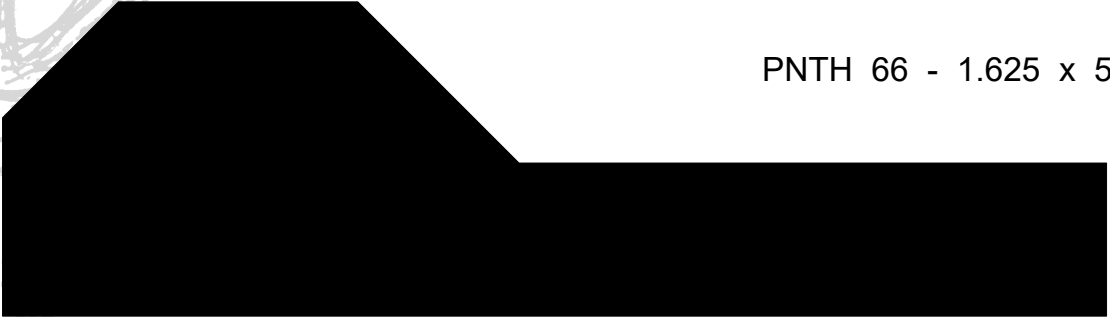

*Chicone*

# Neoclassical

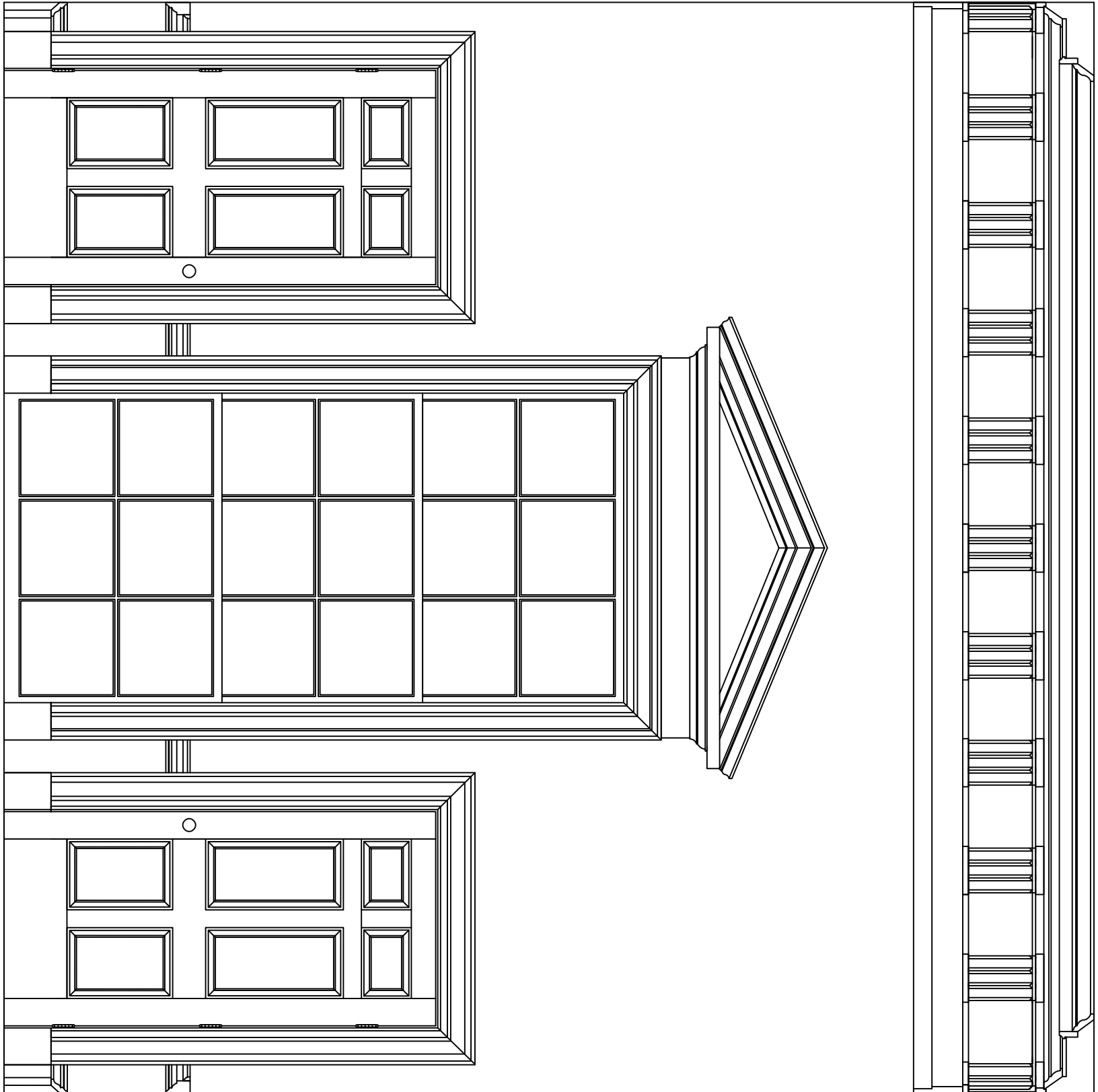



# Neoclassical

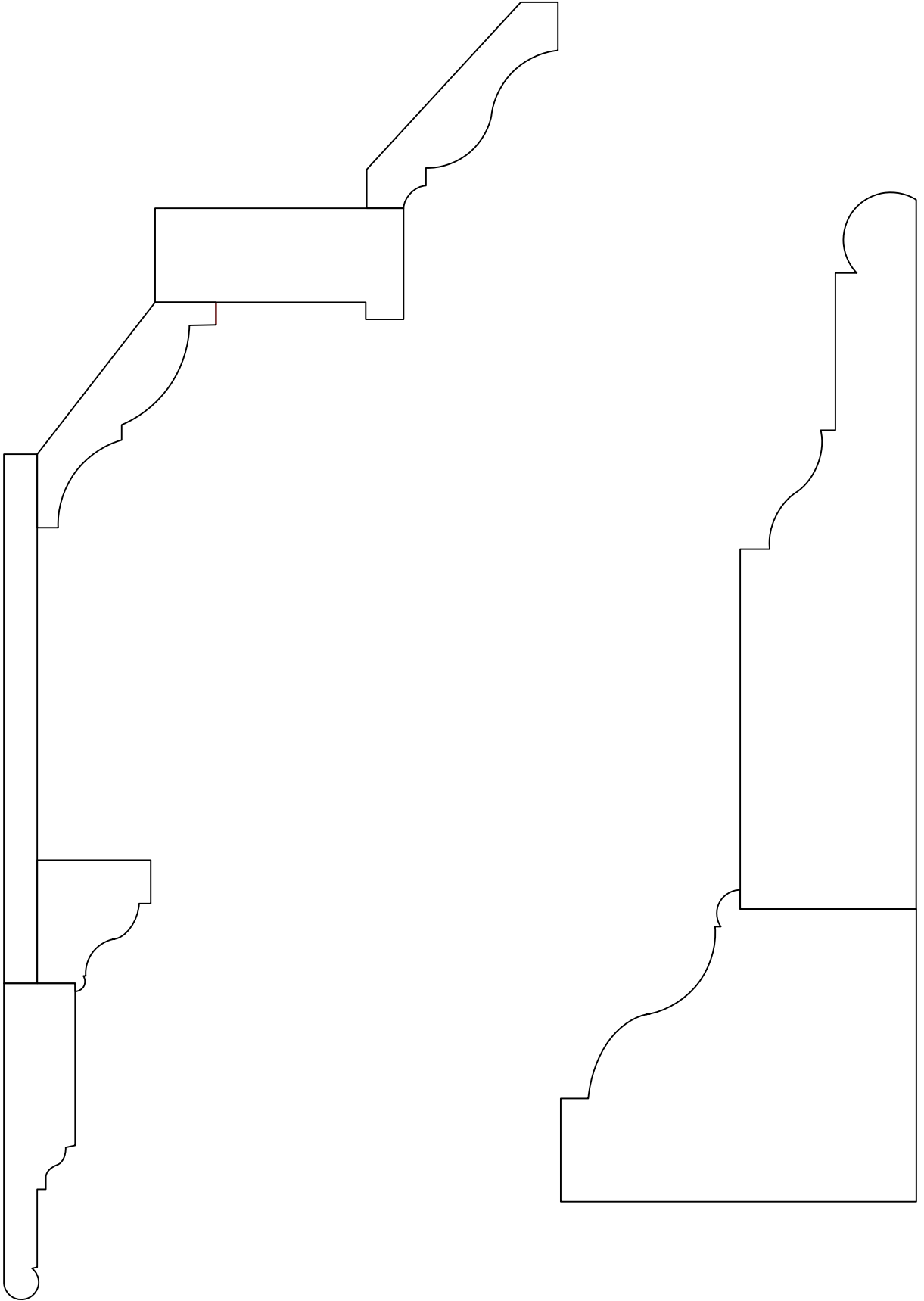

# Neoclassical

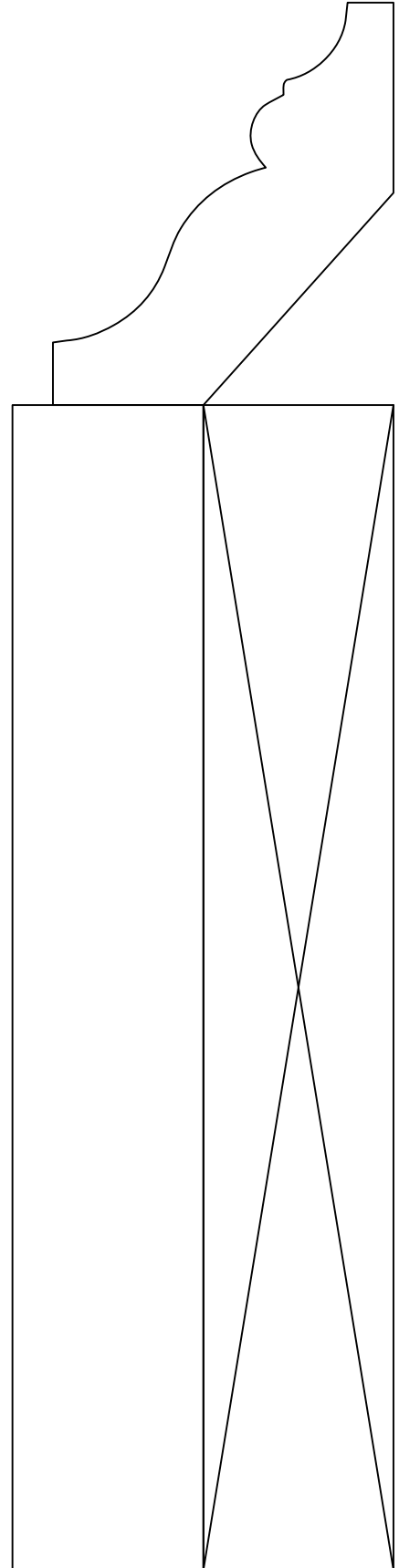
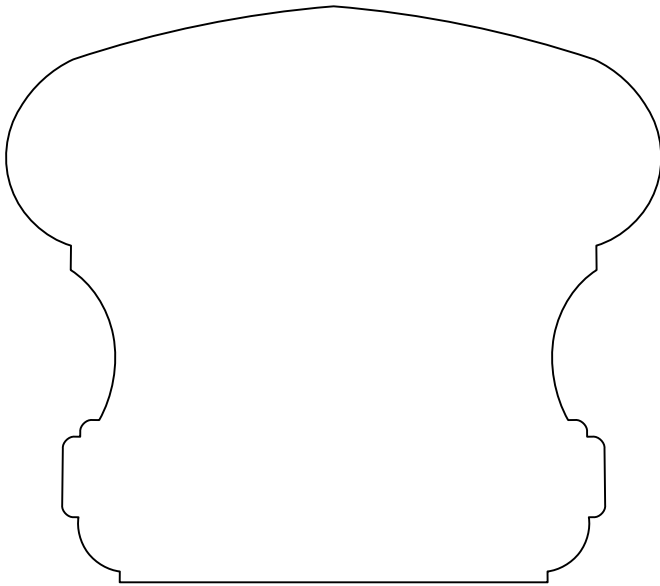

# Neoclassical

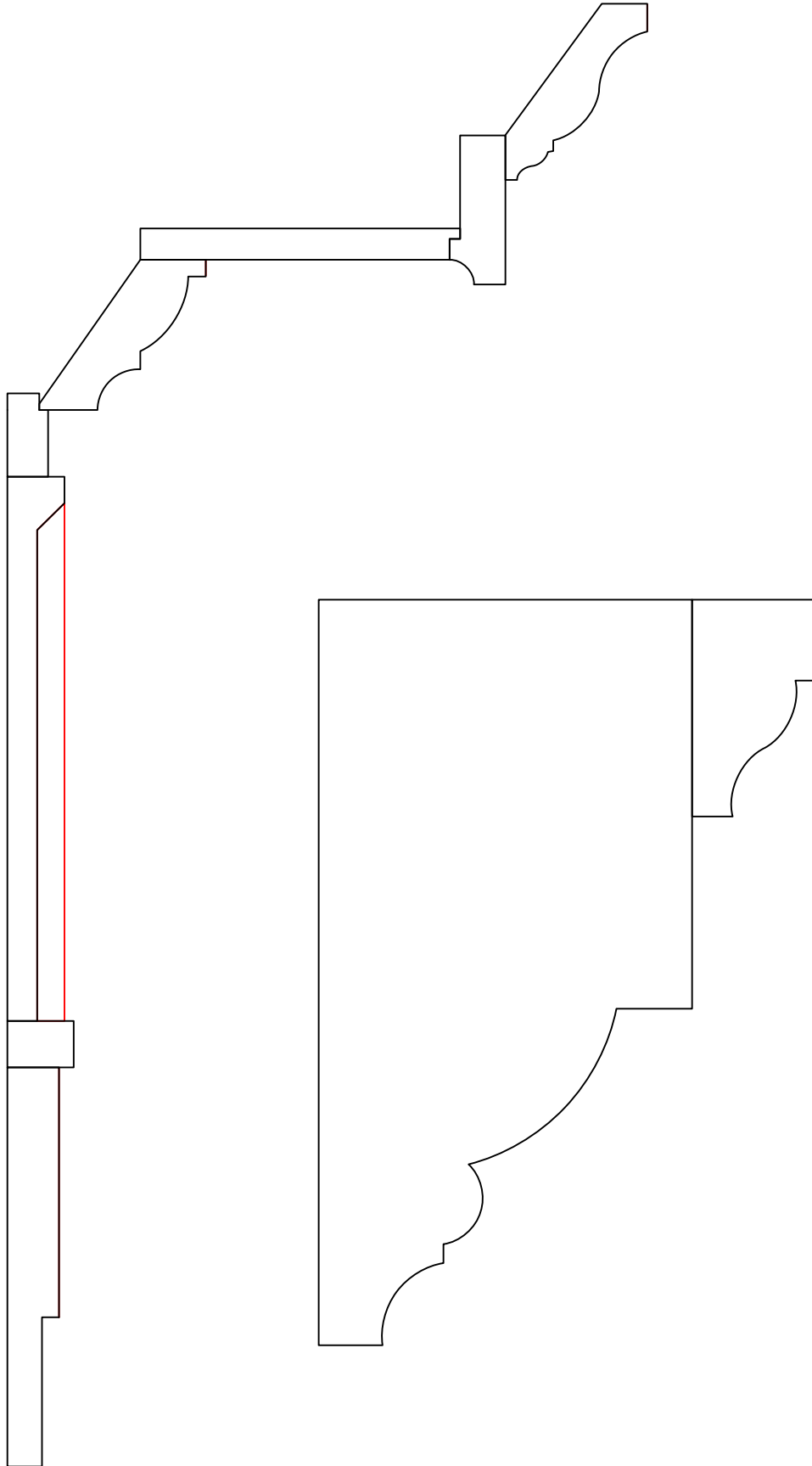

# Neoclassical

CR 36 - 1 x 4.5

CR 40 - 1 x 4.625

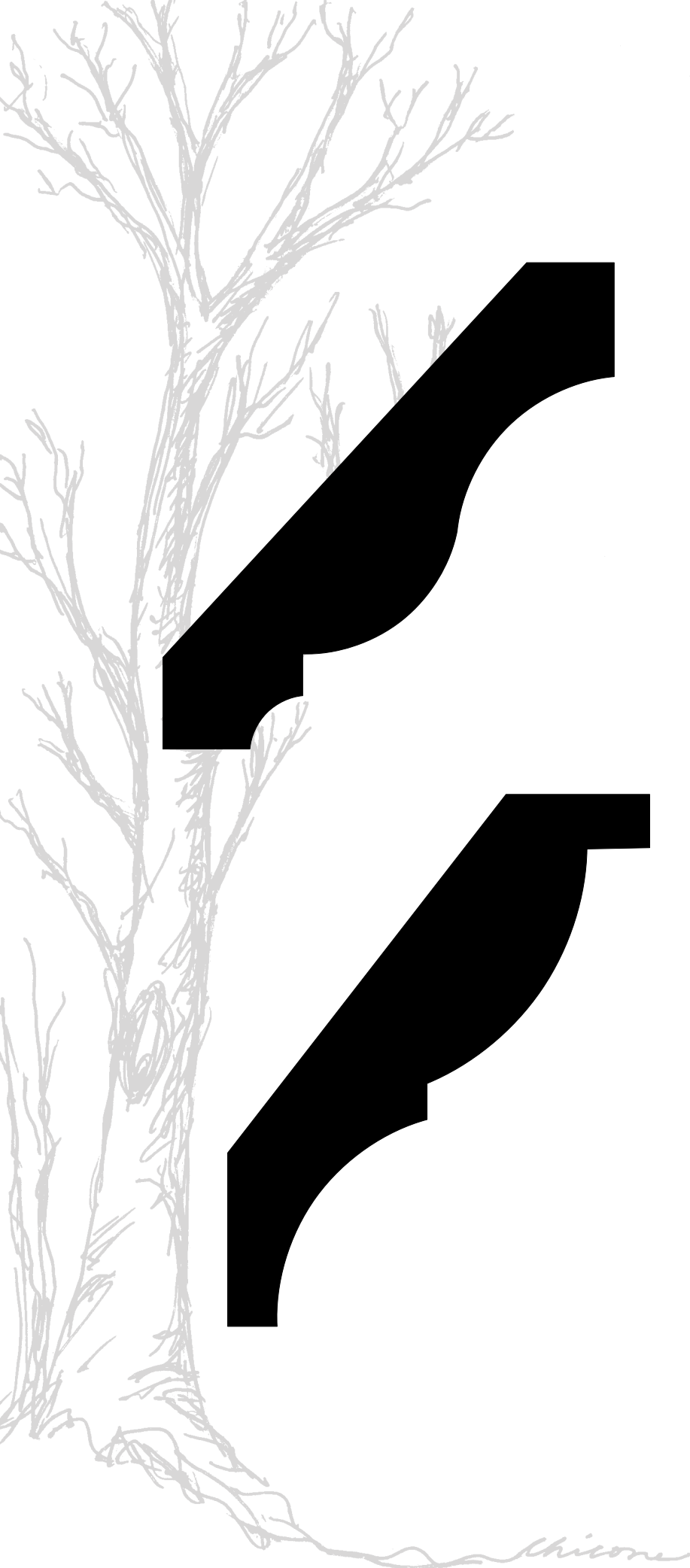

# Neoclassical



T 127 - 1.75 x 4



BB 14 - 1.875 x 2.25



BB 15 - 2.5 x 2.25

S4S - .5 x 8.625



# Neoclassical

C 397 - 1.125 x 5.125



C 398 - 1.25 x 4.875



HR 17 - 3 x 3.375  
Neoclassical

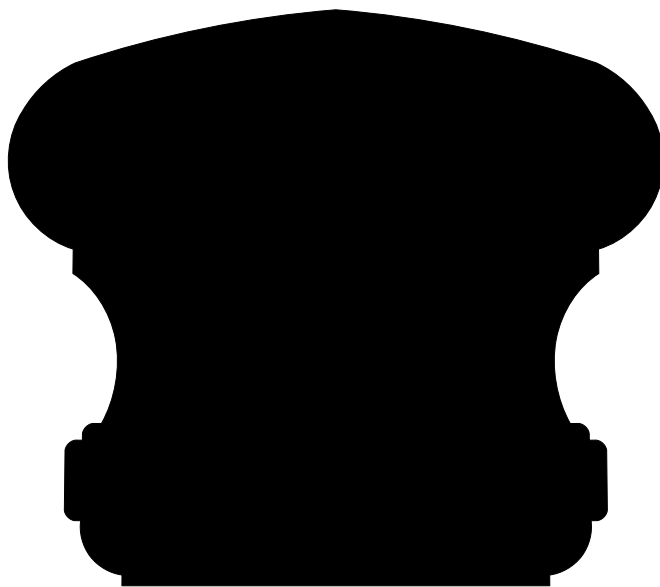

# Neoclassical



CR 41 - 1.375 x 5.375



CR 42 - 1.5 x 5.375



*Chicone*

# Neoclassical



T 128 - 1.313 x 3.5



T 129 - .75 x 7.688



T 130 - 1 x 2

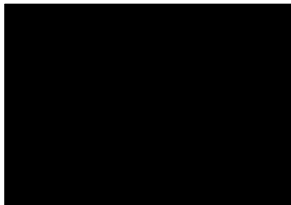

S4S - 1 x 1.5



*Chicone*



# Neoclassical



B 159 a upper - 1.25 x 6  
B 159 b lower - .813 x 3.813  
1.25 x 9.5 \*\*\*



B 160 a upper - 1.5 x 5.938  
B 160 b lower - 1.5 x 7.5  
1.5 x 13.688 \*\*\*  
two pieces

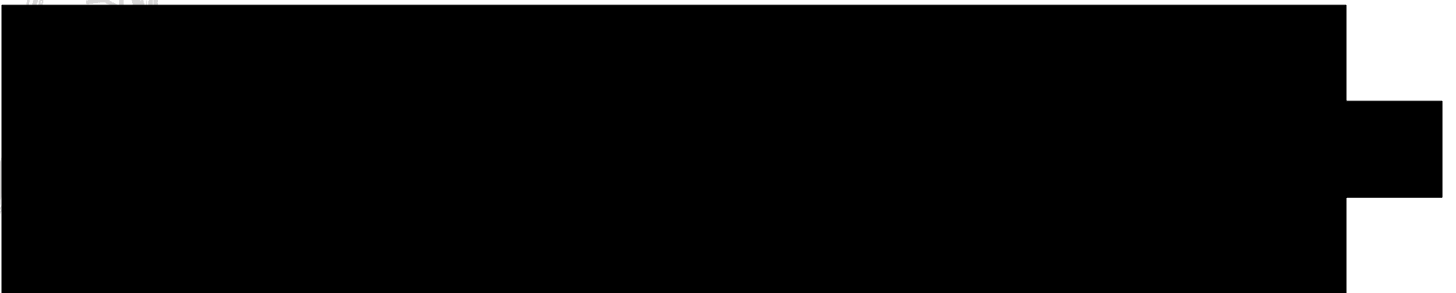

# Neoclassical



S4S - 1 x 1.875



T 153 - .625 x 3.25



T 154 - 1.375 x 7



T 154 a - .75 x 6.25



T 126 - .75 x 1.375

# Neoclassical

CR 38 - 2 x 2.938

CR 39 - 2.25 x 4.5

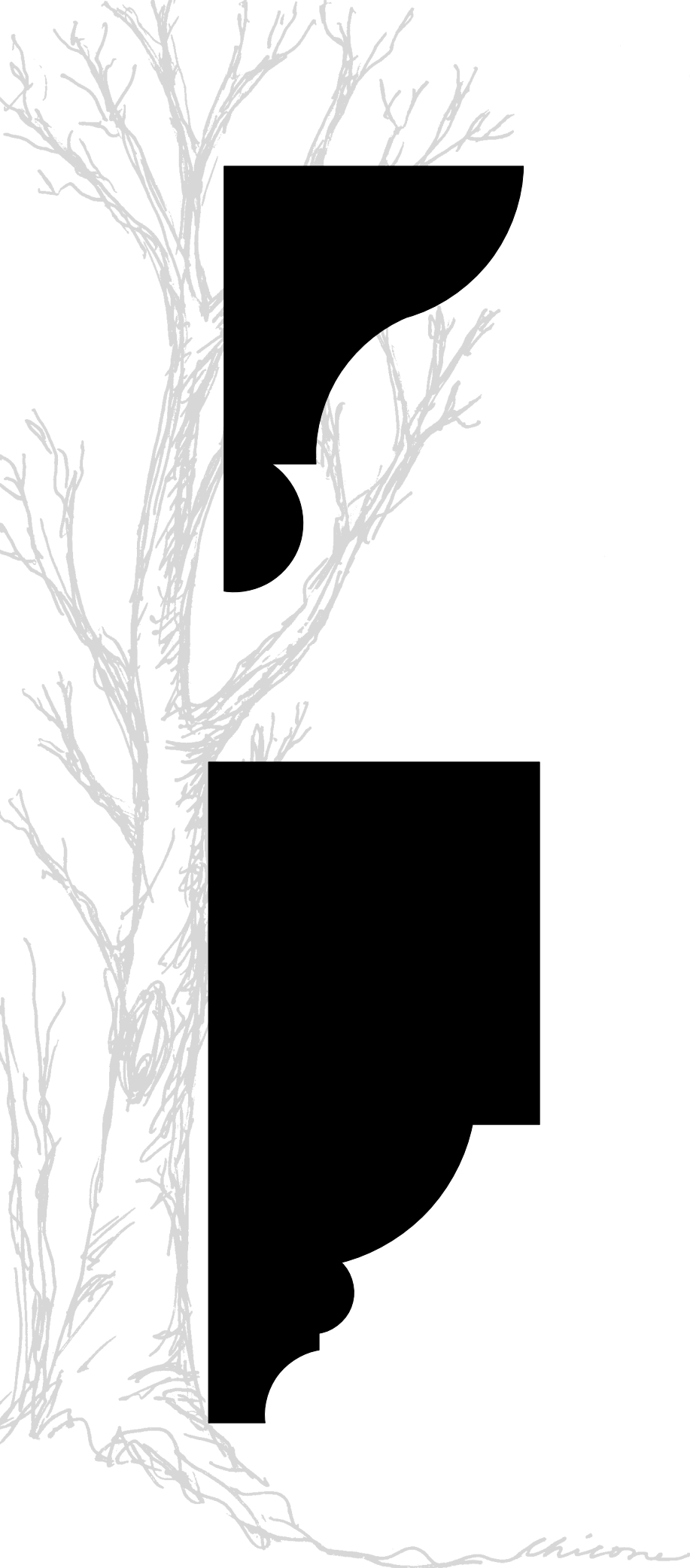

# Neoclassical



CR 37 - 1.125 x 4.188

S4S - 1.5 x 9.25

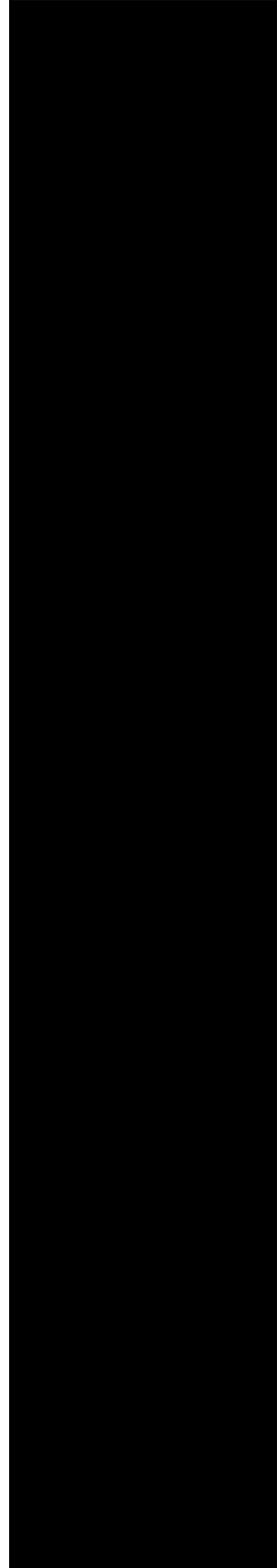

*Chicone*

# New England Colonial

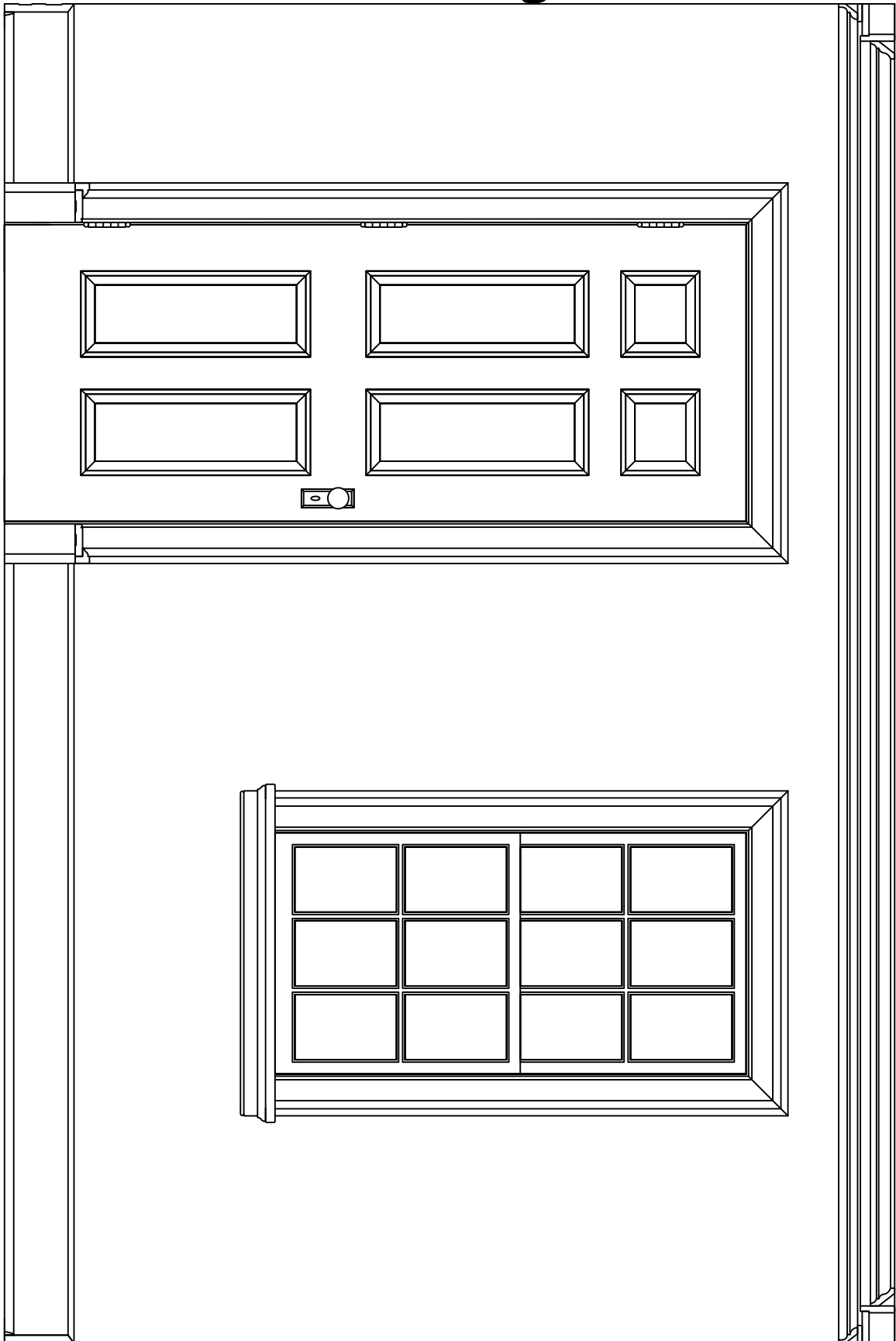

# New England Colonial

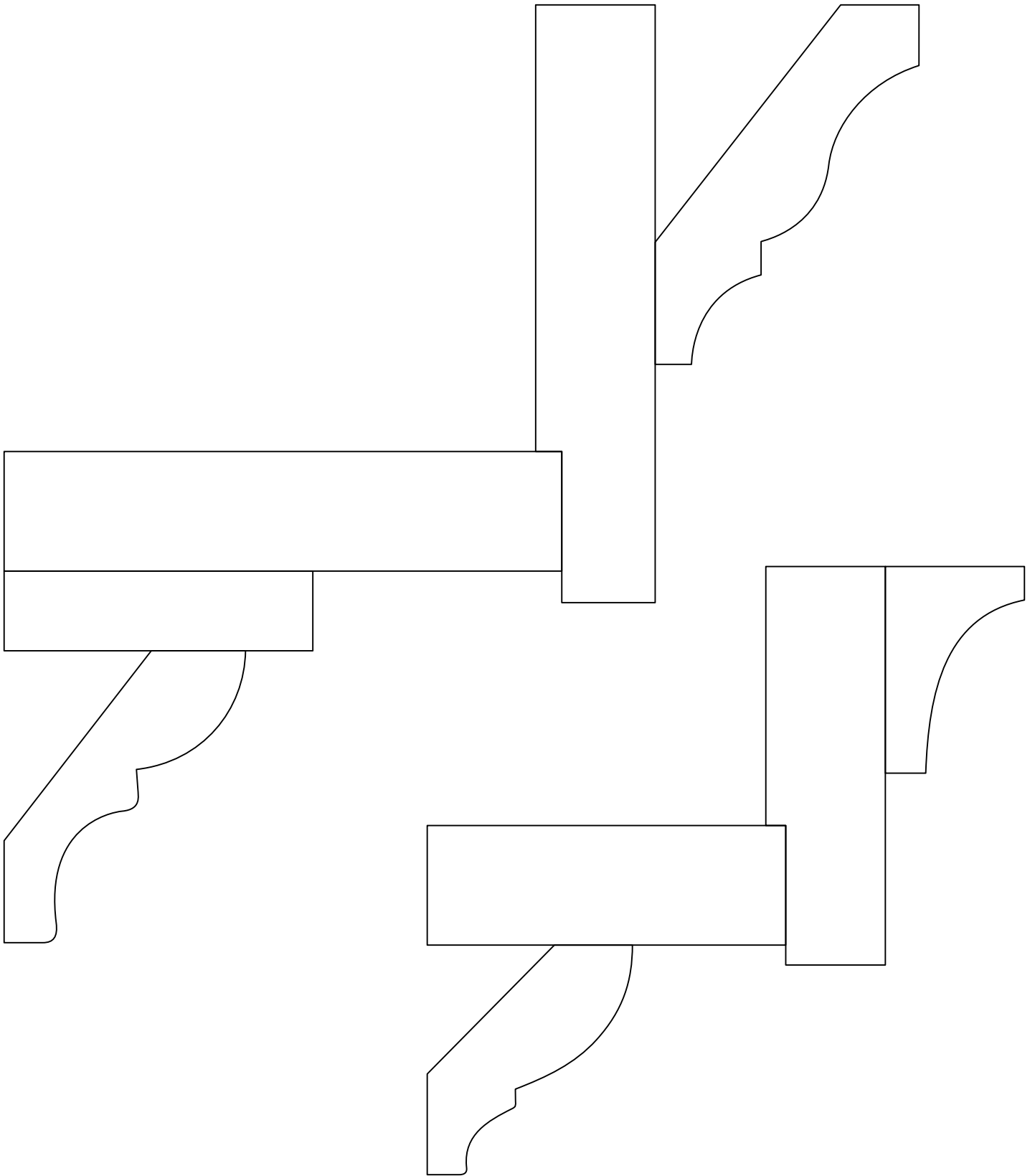

# New England Colonial

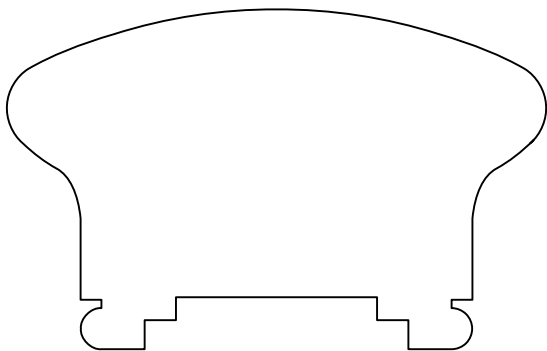
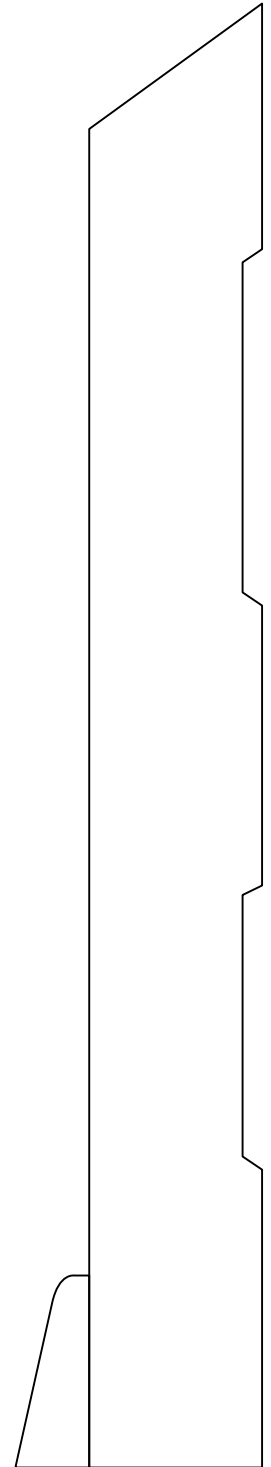
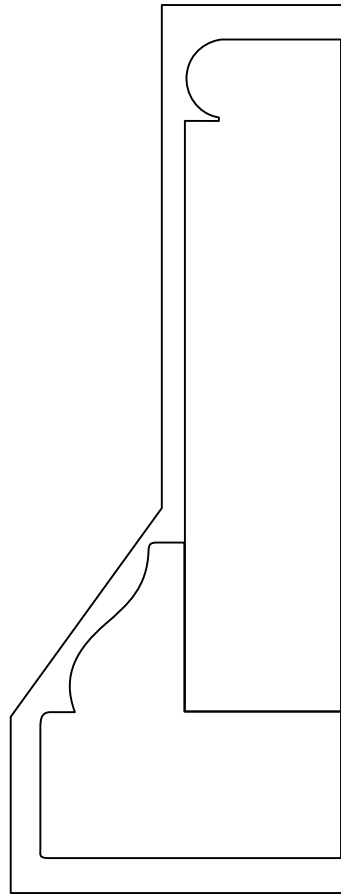
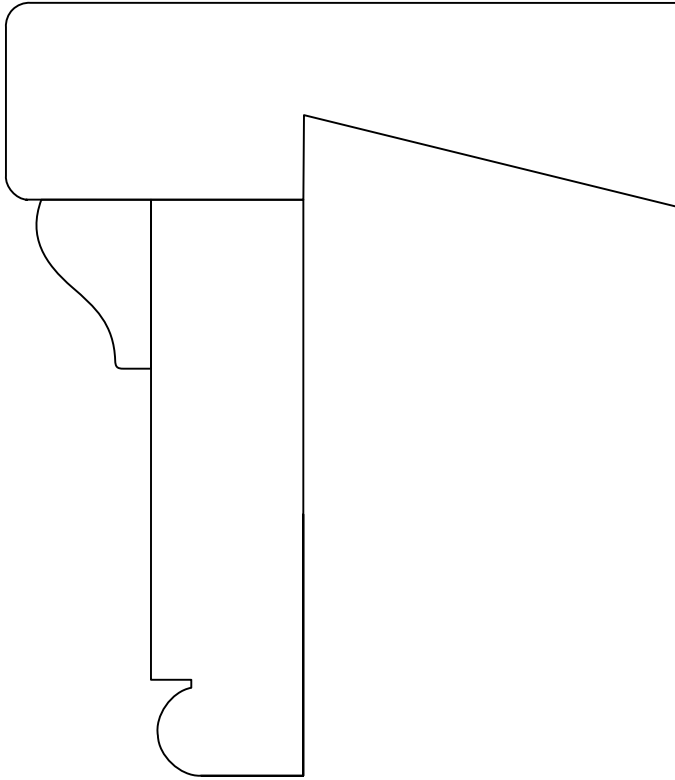

# New England Colonial



PNTH 65 - 1.75 x 4.625



BB 154 - 1.5 \*\*\* x 1.625



C 252 a - .813 x 3.5



S 20 - 1.125 x 3.5



SM 36 - .938 x .625



# New England Colonial



B 664 - .938 x 7.625 \*\*\*



SM 35 - .375 x 1

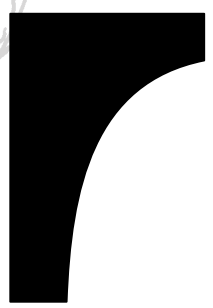

CV 74 - 1 x 1.5



CHR 73 a - .75 x 2.5



CHR 74 a - .75 x 3.75

*Chicone*

# New England Colonial



CR 1260 - .75 x 2.25

CR 1261 - .75 x 2.75

CR 351 - .75 x 3.25

# New England Colonial



S4S - .5 x 1.938



S4S - .75 x 3.5



S4S - .75 x 2.25

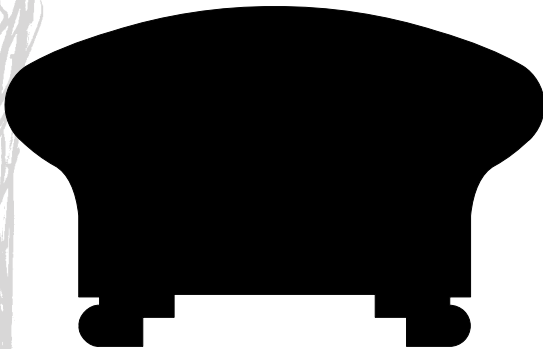

HR 10 - 1.75 x 2.75

# Octagon

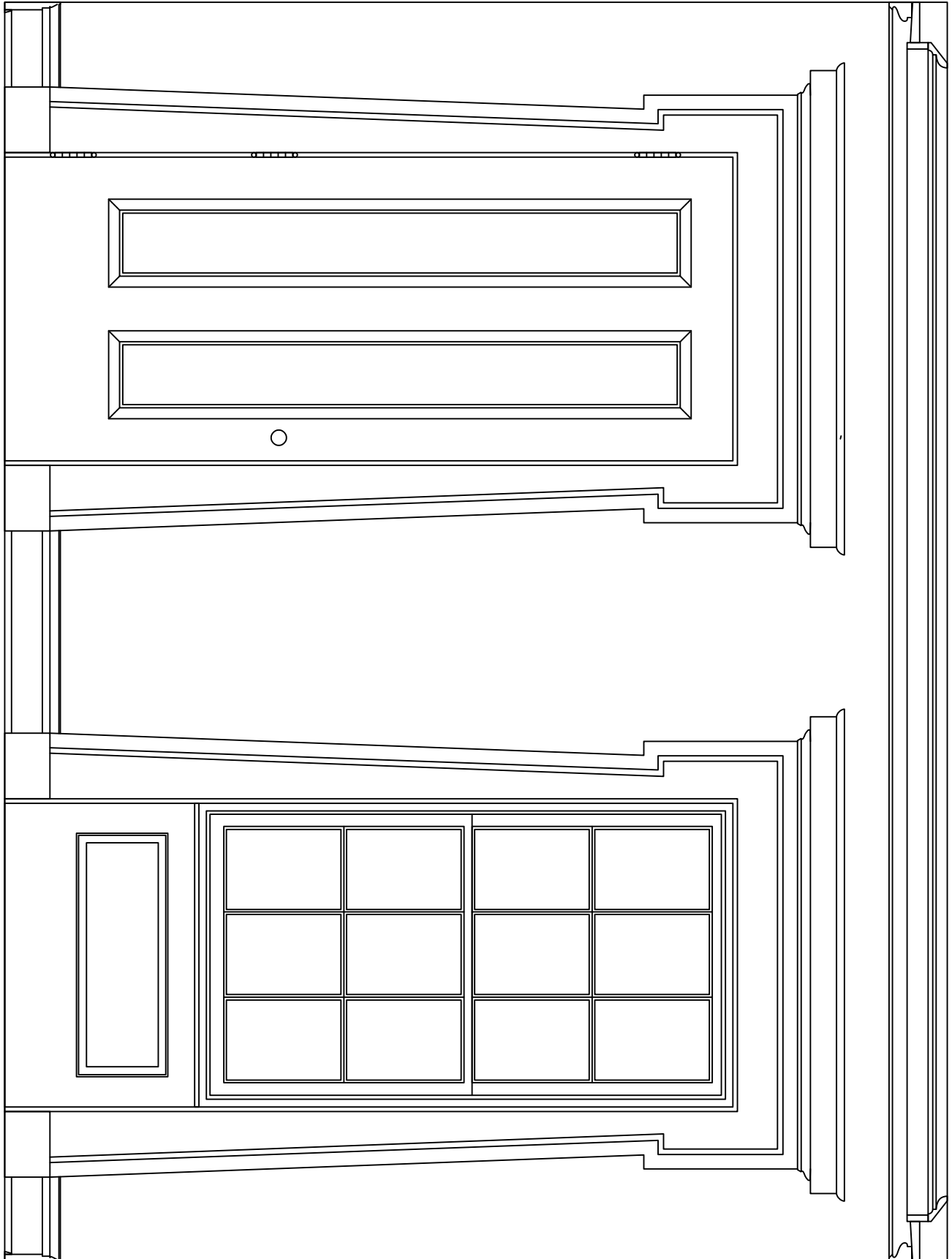

# Octagon

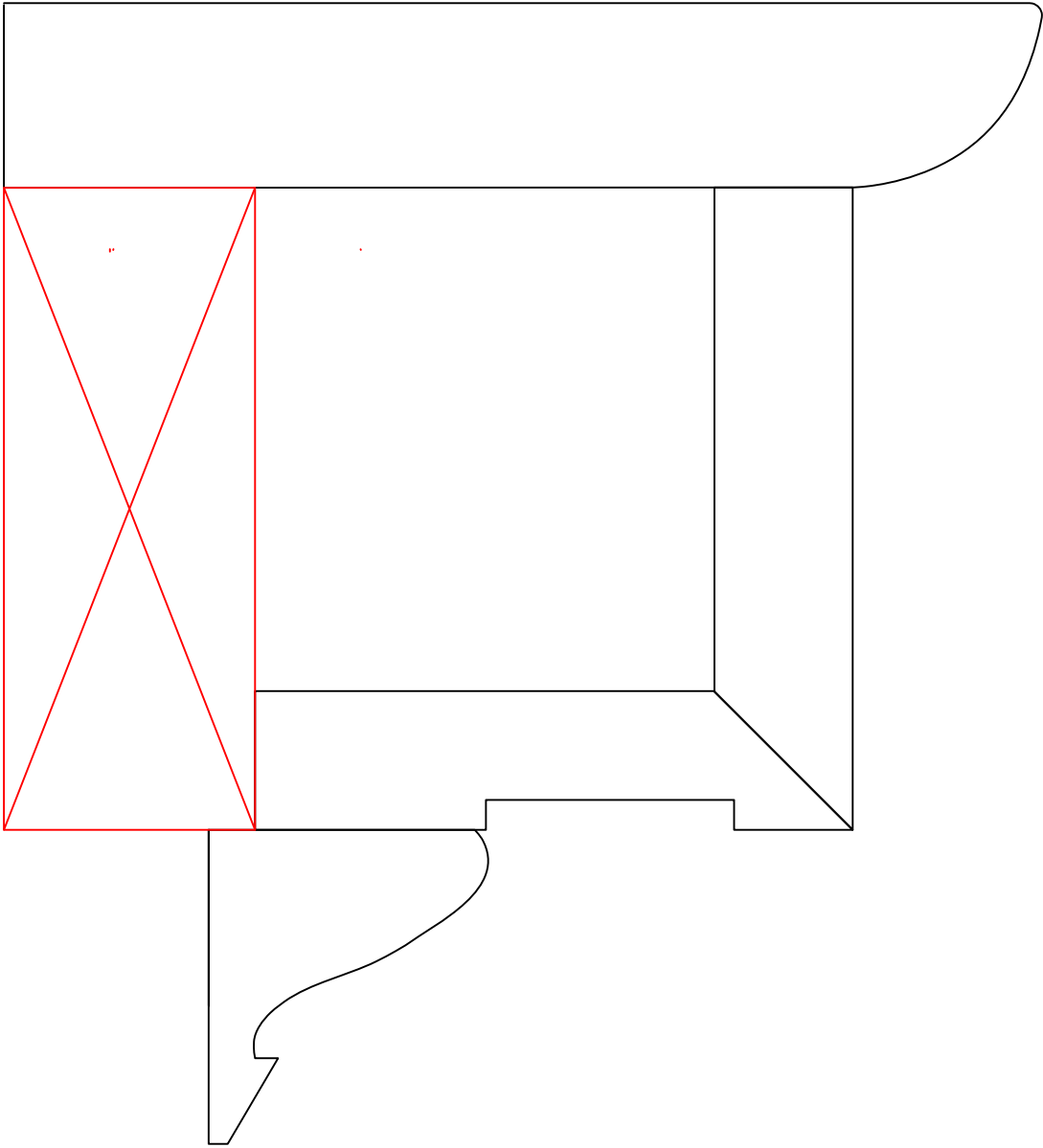

# Octagon

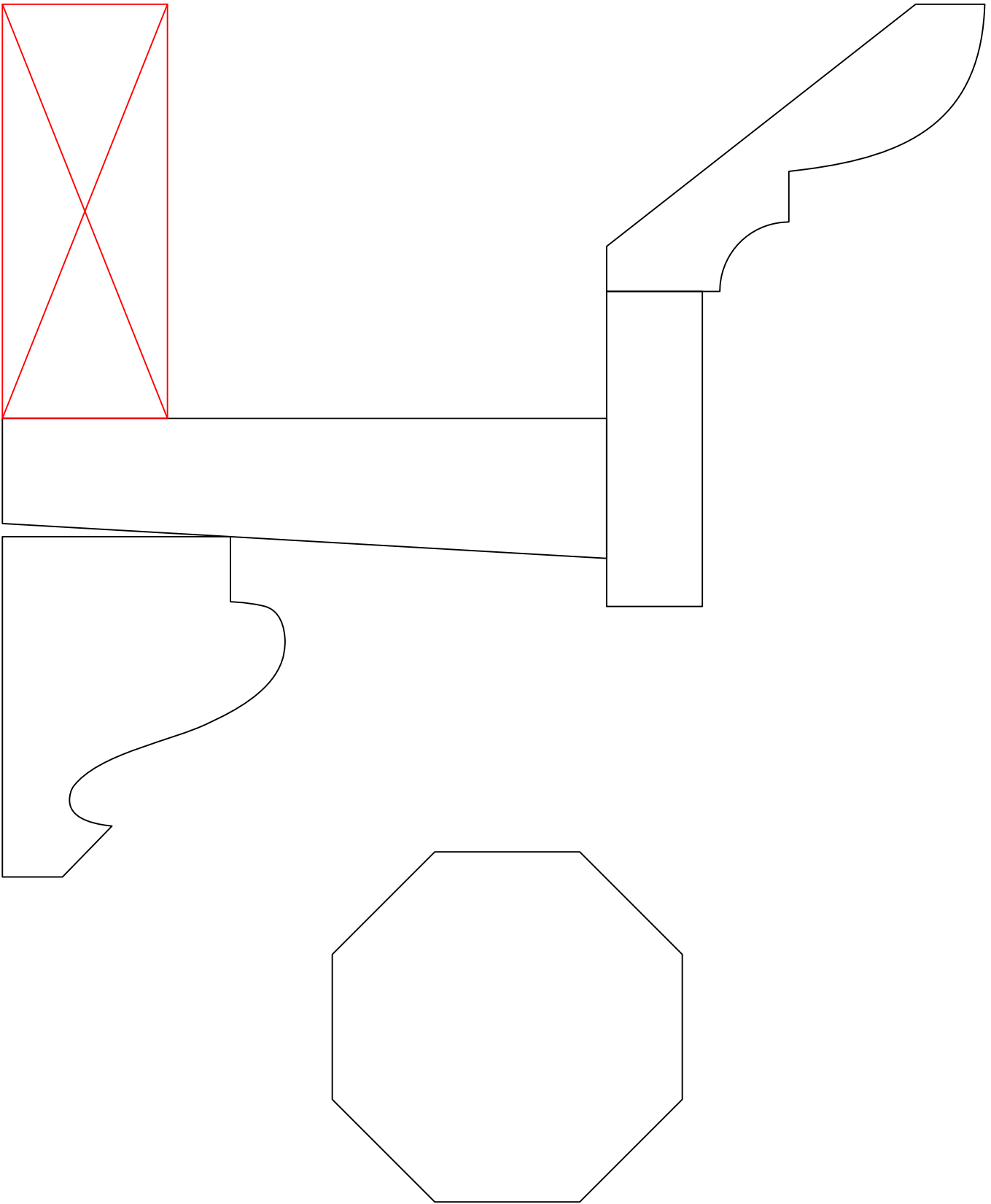

# Octagon

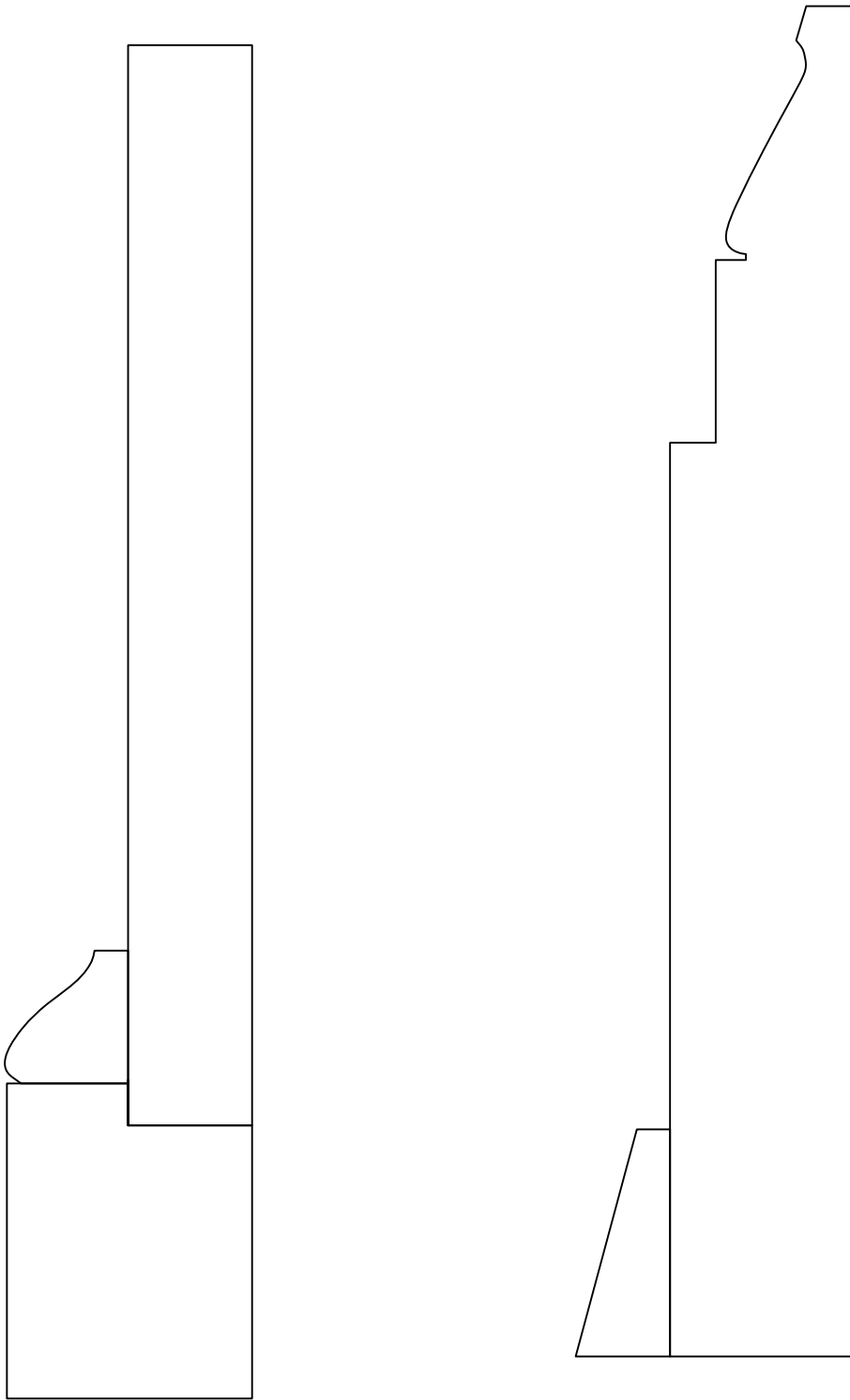

# Octagon



B 154 - 1 x 5.688 \*\*



B 153 - .75 x 3.5 \*\*



B 153 a - .75 x 3.25 \*\*



S4S - .188 x 1.375



CR 30 - 1.5 x 1.688



SM 14 - .5 x 1.25



# Octagon



S4S - .688 x 6



T 116 - .688 x .75

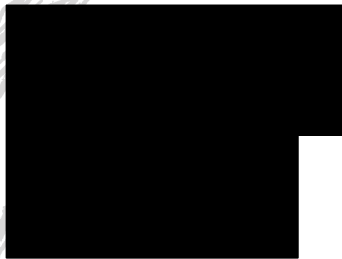

T 117 - 1.313 x 1.75



S4S - .688 x 2.5



B 155 - 1 x 4.313

# Octagon

CR 29 - .75 x 3.375



BC 265 - 2 x 2.375

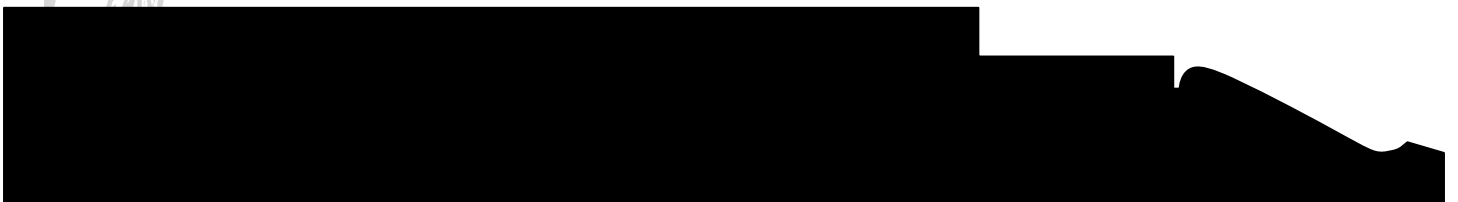

B 152 - 1.032 x 7.5 \*\*

# Octagon

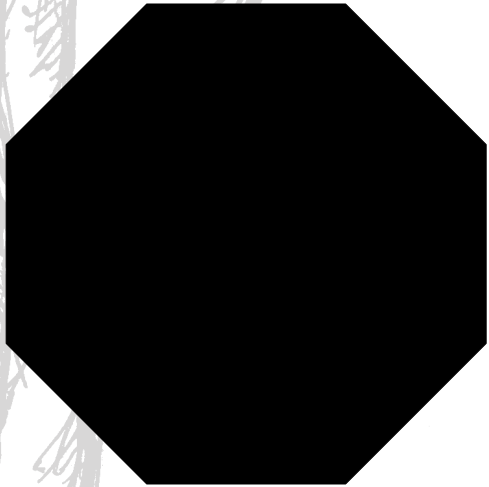

HR 6011 - 2.5 x 2.5  
Octagon

# Palladian

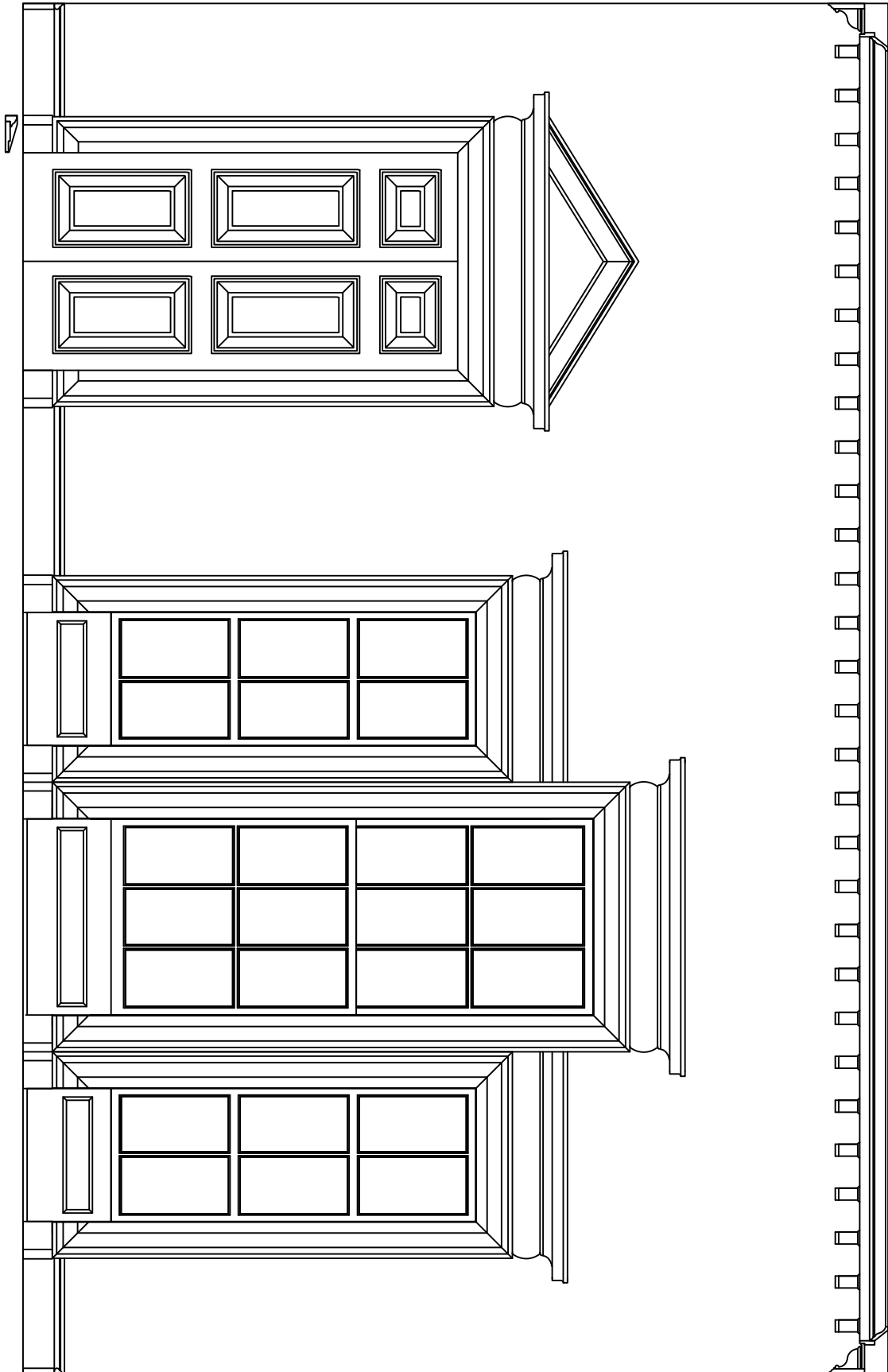

# Palladian

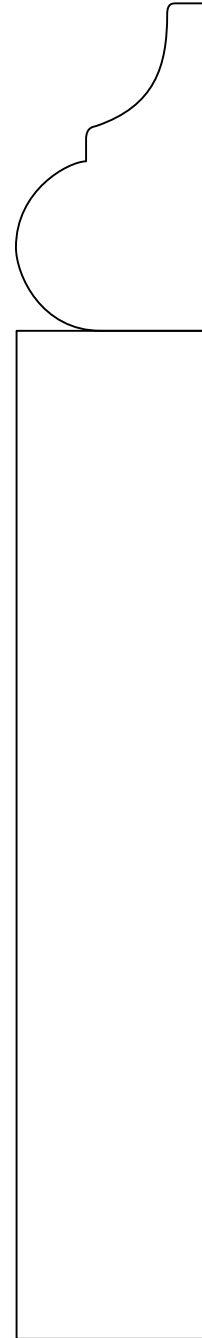
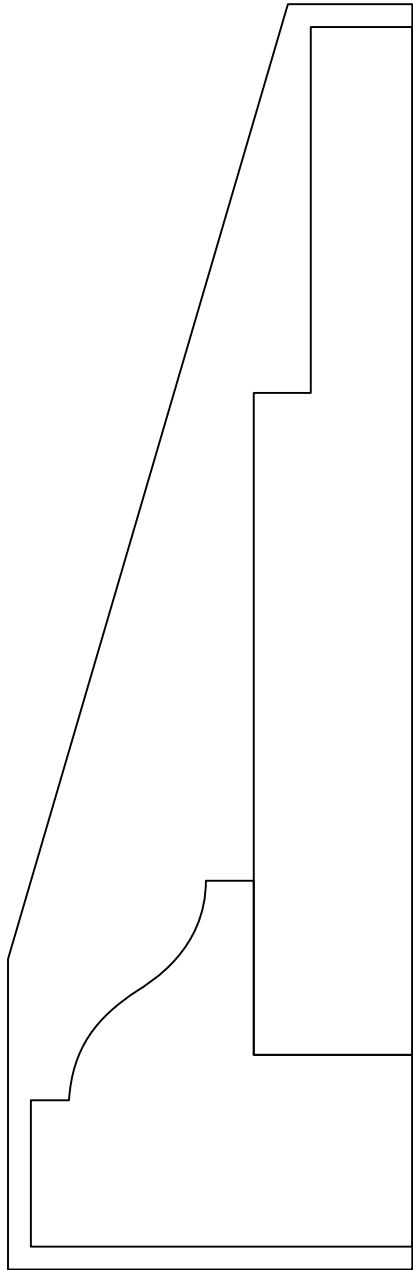

# Palladian

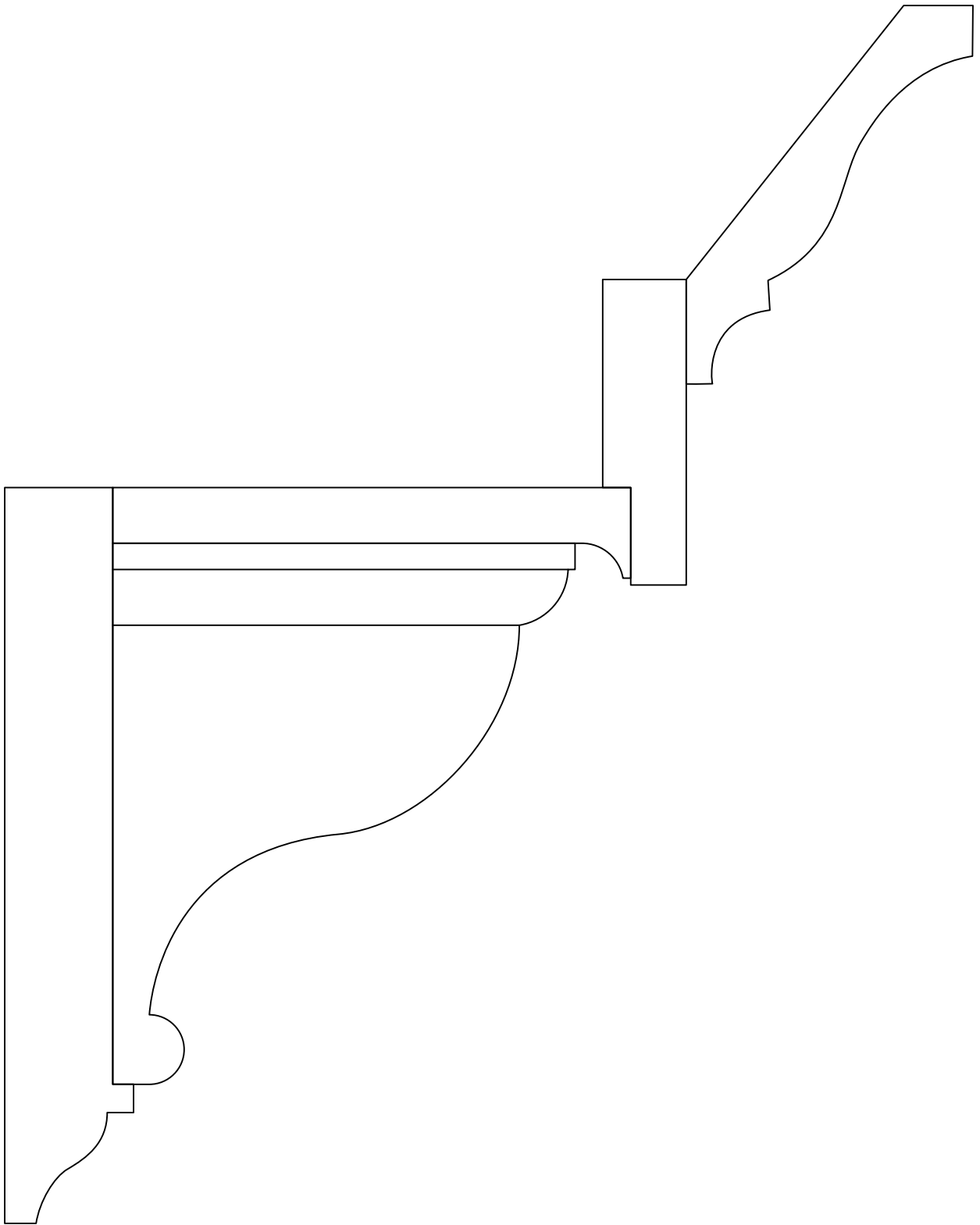

# Palladian

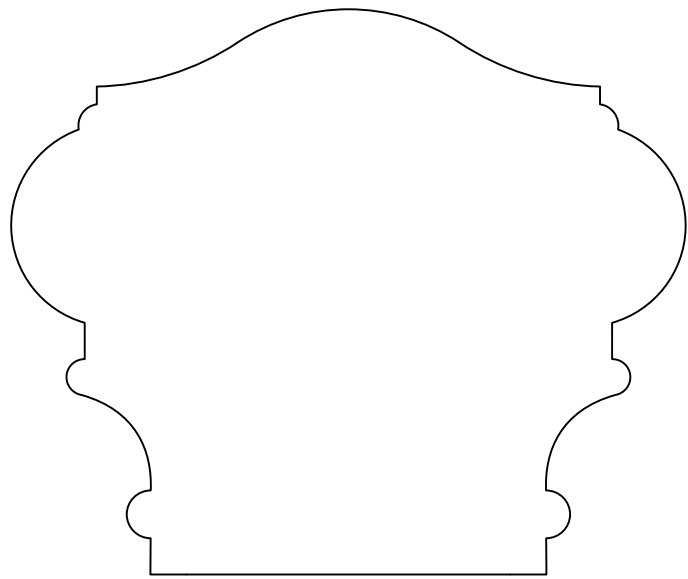
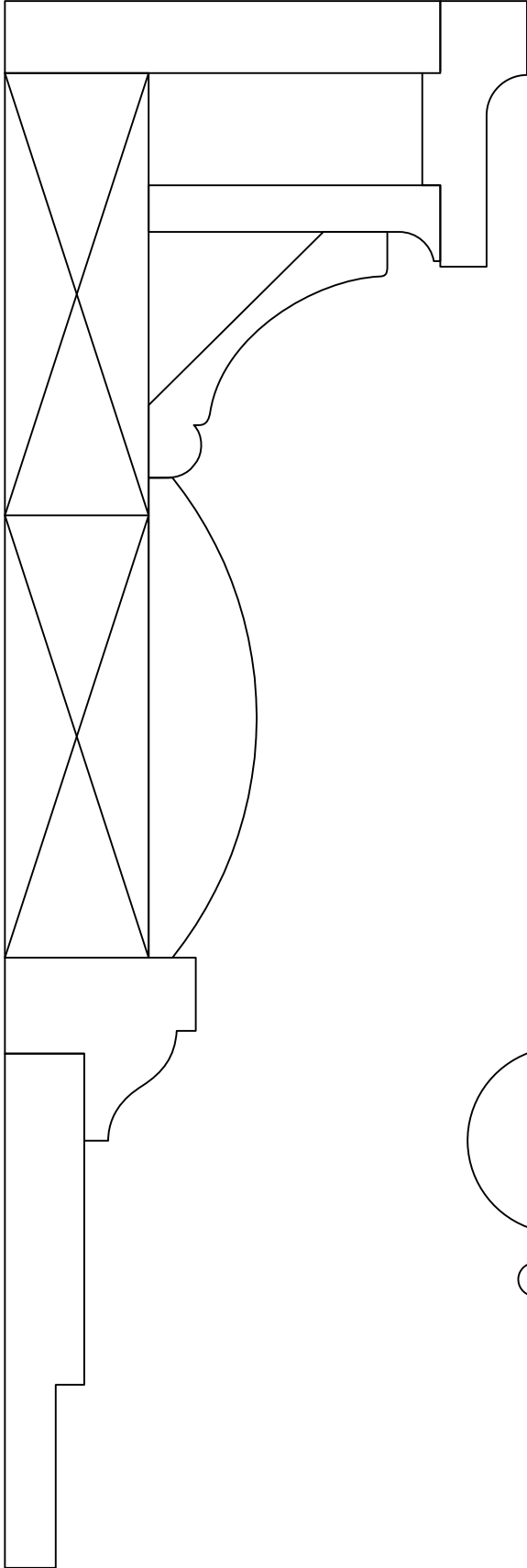

# Pallidian

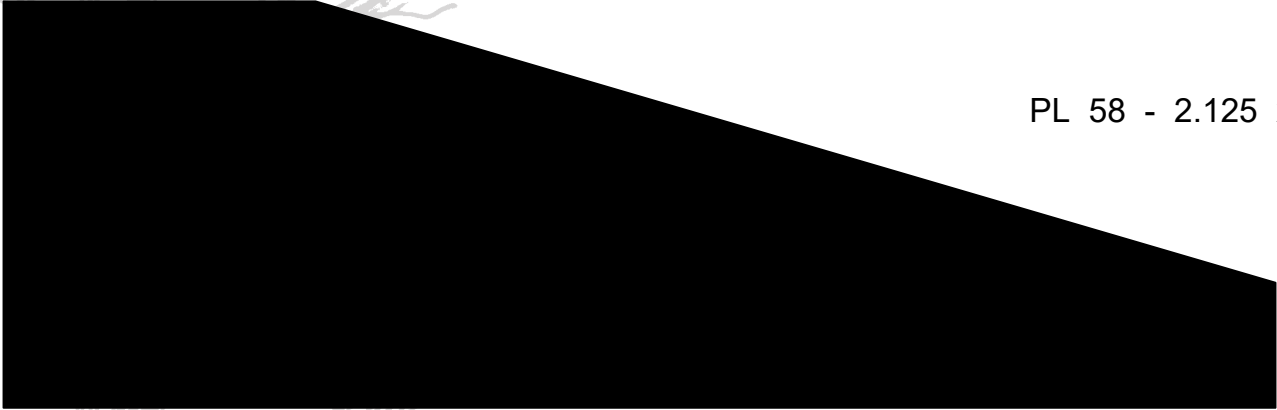

PL 58 - 2.125 x 6.625



BB 155 - 2 \*\*\* x 1.938



CR 1263 - .875 x 5.625



CR 1264 - .75 x 4.5



# Pallidian



HR 72 - 2.938 x 2.938



M 14 - 4.75 x 3.5

# Palladian



CR 1266 - 1.125 x 6.5



CR 112 - .75 x 4.25



CR 1262 - .75 x 3.5



T 114 - .75 x .5

# Pallidian



CR 1267 - 1.063 x 2.75

CHR 73 b - .75 x 2.75

CR 1265 - .75 x 3

S4S - 1 x 5.375

# Palladian



N 4 - 1 x 1.75

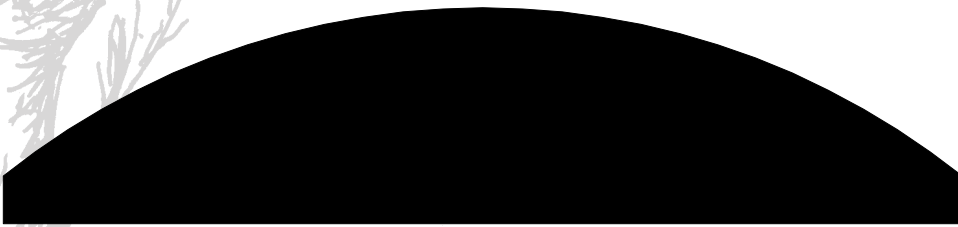

M 7 1.125 x 5

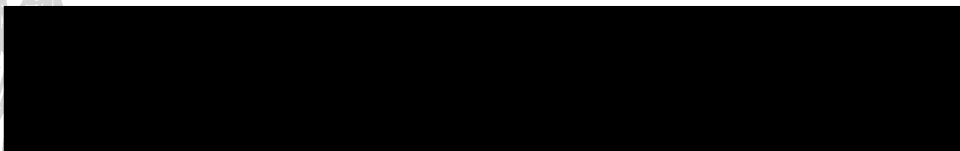

S 4S - .75 x 5

